



SGM8709

Micro-Power, CMOS Input, RRIO, 1.4V, Open Drain Output Comparator

GENERAL DESCRIPTION

The SGM8709 is an ultra low power comparator with a typical power supply current of 318nA. It has the best-in-class power supply current versus propagation delay performance. The propagation delay is as low as 6 μ s with 100mV overdrive at 1.4V supply.

Designed to operate over a wide range of supply voltages, from 1.4V to 5.5V, with guaranteed operation at 1.4V, 2.5V and 5.0V, the SGM8709 is ideal for use in a variety of battery-powered applications. With rail-to-rail input common mode voltage range, the SGM8709 is well suited for single-supply operation. Its small packages make this device ideal for use in handheld electronics and mobile phone applications.

Featuring an open drain output stage, the SGM8709 allows for operation with absolute minimum power consumption when driving any capacitive or resistive load.

SGM8709 is available in Green SOT-23-5 and SC70-5 space-saving packages. It is rated over the -40°C to +85°C temperature range.

FEATURES

- **Ultra Low Power Consumption:**
318nA (TYP) at $V_S = 1.4V$
- **Wide Supply Voltage Range: 1.4V to 5.5V**
- **Propagation Delay: 6 μ s (TYP) at $V_S = 1.4V$**
- **Open Drain Output Current Drive:**
18.7mA (TYP) at $V_S = 5V$
- **Rail-to-Rail Input**
- **N-MOSFET Open Drain Output Structure**
- **-40°C to +85°C Operating Temperature Range**
- **Available in Green SOT-23-5 and SC70-5 Packages**

APPLICATIONS

- RC Timers
- Window Detectors
- IR Receiver
- Multivibrators
- Alarm and Monitoring Circuits

TYPICAL APPLICATION

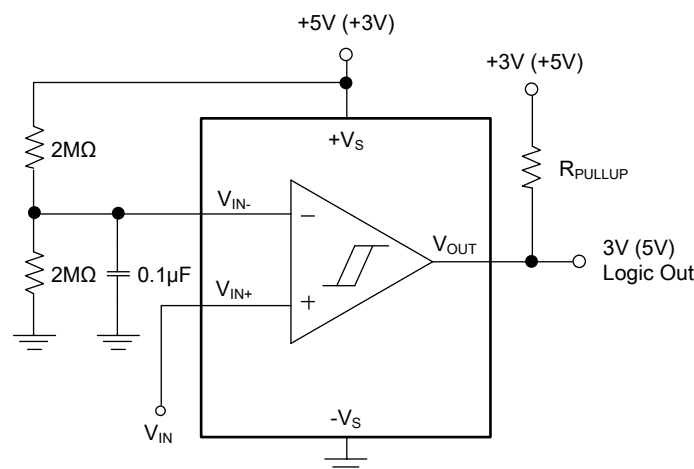

ELECTRICAL CHARACTERISTICS(At $T_A = +25^\circ\text{C}$, $+V_S = 1.4\text{V}$, $-V_S = 0\text{V}$, $V_{CM} = +V_S/2$, $V_{OUT} = -V_S$ and $R_L = 20\text{k}\Omega$ connected to $+V_S$, unless otherwise noted.)

PARAMETER	SYMBOL	CONDITIONS	MIN	TYP	MAX	UNITS
Supply Current	I_S	$V_{CM} = 0.3\text{V}$		318	1000	nA
		$V_{CM} = 1.1\text{V}$		263	1000	
Input Offset Voltage	V_{OS}	$V_{CM} = 0\text{V}$		0.6	3	mV
		$V_{CM} = 1.4\text{V}$		0.4	3	
Input Offset Average Drift				2		$\mu\text{V}/^\circ\text{C}$
Common Mode Rejection Ratio	CMRR	V_{CM} stepped from 0V to 0.3V		61		dB
		V_{CM} stepped from 0.8V to 1.4V		59		
		V_{CM} stepped from 0V to 1.4V		67		
Power Supply Rejection Ratio	PSRR	$V_S = 1.8\text{V}$ to 5.5V , $V_{CM} = 0\text{V}$		87		dB
Open-Loop Voltage Gain	A_{OL}			81		dB
Output Voltage Swing from Rail	V_{OL}	$V_S = 1.8\text{V}$, $I_{OUT} = 500\mu\text{A}$		81	106	mV
		$-40^\circ\text{C} \leq T_A \leq +85^\circ\text{C}$			137	
		$V_S = 1.8\text{V}$, $I_{OUT} = 1\text{mA}$		165	213	
		$-40^\circ\text{C} \leq T_A \leq +85^\circ\text{C}$			290	
Output Current	I_{OUT}	Sink	0.7	1.8		mA
		$-40^\circ\text{C} \leq T_A \leq +85^\circ\text{C}$	0.5			
Leakage Current	$I_{Leakage}$	$V_{OUT} = +V_S$		1		nA
Propagation Delay (High to Low)		Overdrive = 10mV		12		μs
		Overdrive = 100mV		6		
Fall Time	t_{Fall}	Overdrive = 10mV, $C_L = 30\text{pF}$, $R_L = 1\text{M}\Omega$		156		ns
		Overdrive = 100mV, $C_L = 30\text{pF}$, $R_L = 1\text{M}\Omega$		155		

ELECTRICAL CHARACTERISTICS (continued)(At $T_A = +25^\circ\text{C}$, $+V_S = 2.5\text{V}$, $-V_S = 0\text{V}$, $V_{CM} = +V_S/2$, $V_{OUT} = -V_S$ and $R_L = 20\text{k}\Omega$ connected to $+V_S$, unless otherwise noted.)

PARAMETER	SYMBOL	CONDITIONS	MIN	TYP	MAX	UNITS
Supply Current	I_S	$V_{CM} = 0.3\text{V}$		330		nA
		$V_{CM} = 2.2\text{V}$		275		
Input Offset Voltage	V_{OS}	$V_{CM} = 0\text{V}$		0.6		mV
		$V_{CM} = 2.5\text{V}$		0.4		
Input Offset Average Drift				2		$\mu\text{V}/^\circ\text{C}$
Common Mode Rejection Ratio	CMRR	V_{CM} stepped from 0V to 1.4V		69		dB
		V_{CM} stepped from 1.9V to 2.5V		68		
		V_{CM} stepped from 0V to 2.5V		72		
Power Supply Rejection Ratio	PSRR	$V_S = 1.8\text{V}$ to 5.5V , $V_{CM} = 0\text{V}$		87		dB
Open-Loop Voltage Gain	A_{OL}			80		dB
Output Voltage Swing from Rail	V_{OL}	$I_{OUT} = 500\mu\text{A}$		66		mV
		$I_{OUT} = 1\text{mA}$		131		
Output Current	I_{OUT}	Sink		7.1		mA
Leakage Current	$I_{Leakage}$	$V_{OUT} = +V_S$		2		nA
Propagation Delay (High to Low)		Overdrive = 10mV		11		μs
		Overdrive = 100mV		5		
Fall Time	t_{Fall}	Overdrive = 10mV, $C_L = 30\text{pF}$, $R_L = 1\text{M}\Omega$		64		ns
		Overdrive = 100mV, $C_L = 30\text{pF}$, $R_L = 1\text{M}\Omega$		48		

ELECTRICAL CHARACTERISTICS (continued)(At $T_A = +25^\circ\text{C}$, $+V_S = 5.0\text{V}$, $-V_S = 0\text{V}$, $V_{CM} = +V_S/2$, $V_{OUT} = -V_S$ and $R_L = 20\text{k}\Omega$ connected to $+V_S$, unless otherwise noted.)

PARAMETER	SYMBOL	CONDITIONS	MIN	TYP	MAX	UNITS
Supply Current	I_S	$V_{CM} = 0.3\text{V}$		366	2000	nA
		$V_{CM} = 4.7\text{V}$		311	2000	
Input Offset Voltage	V_{OS}	$V_{CM} = 0\text{V}$		0.6	3	mV
		$V_{CM} = 5\text{V}$		0.4	3	
Input Offset Average Drift				2		$\mu\text{V}/^\circ\text{C}$
Common Mode Rejection Ratio	CMRR	V_{CM} stepped from 0V to 3.9V		69		dB
		V_{CM} stepped from 4.4V to 5.0V		75		
		V_{CM} stepped from 0V to 5.0V		77		
Power Supply Rejection Ratio	PSRR	$V_S = 1.8\text{V}$ to 5.5V , $V_{CM} = 0\text{V}$		87		dB
Open-Loop Voltage Gain	A_{OL}			81		dB
Output Voltage Swing from Rail	V_{OL}	$I_{OUT} = 500\mu\text{A}$		53	72	mV
		$-40^\circ\text{C} \leq T_A \leq +85^\circ\text{C}$			92	
		$I_{OUT} = 1\text{mA}$		104	124	
		$-40^\circ\text{C} \leq T_A \leq +85^\circ\text{C}$			152	
Output Current	I_{OUT}	Sink	15.3	18.7		mA
		$-40^\circ\text{C} \leq T_A \leq +85^\circ\text{C}$	12.1			
Leakage Current	$I_{Leakage}$	$V_{OUT} = +V_S$		5		nA
Propagation Delay (High to Low)		Overdrive = 10mV		13		μs
		Overdrive = 100mV		5		
Fall Time	t_{Fall}	Overdrive = 10mV, $C_L = 30\text{pF}$, $R_L = 1\text{M}\Omega$		40		ns
		Overdrive = 100mV, $C_L = 30\text{pF}$, $R_L = 1\text{M}\Omega$		36		

SIMPLIFIED SCHEMATIC DIAGRAM

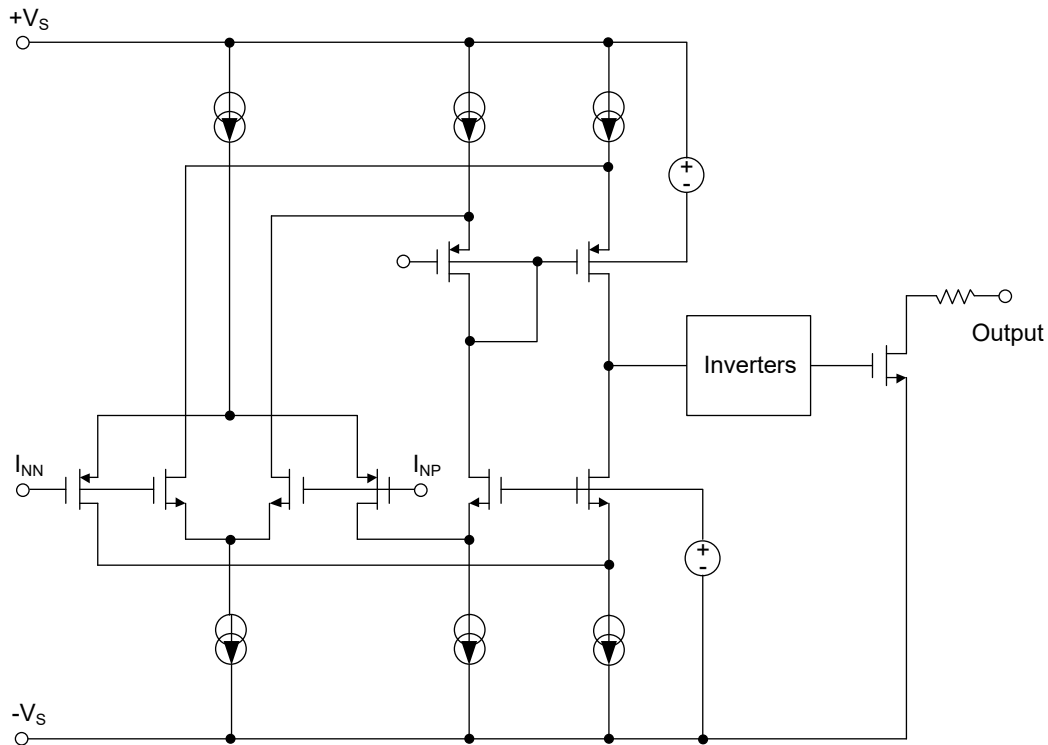

TYPICAL PERFORMANCE CHARACTERISTICS

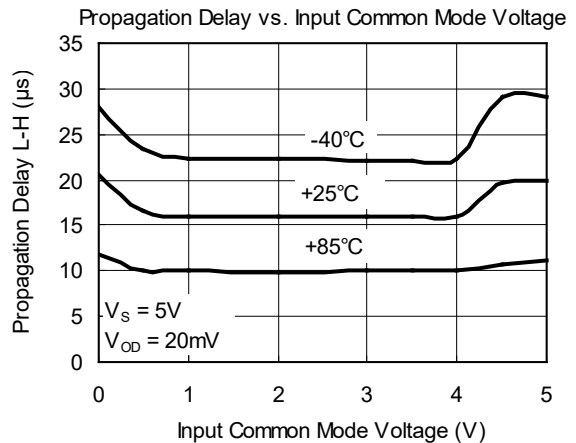
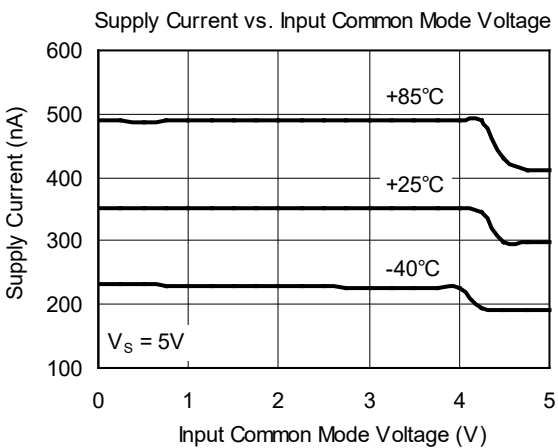
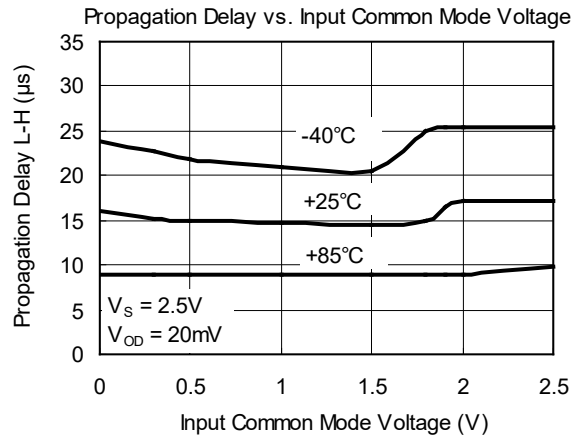
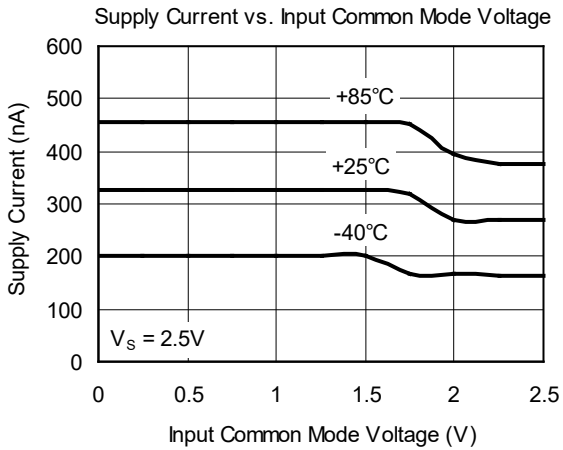
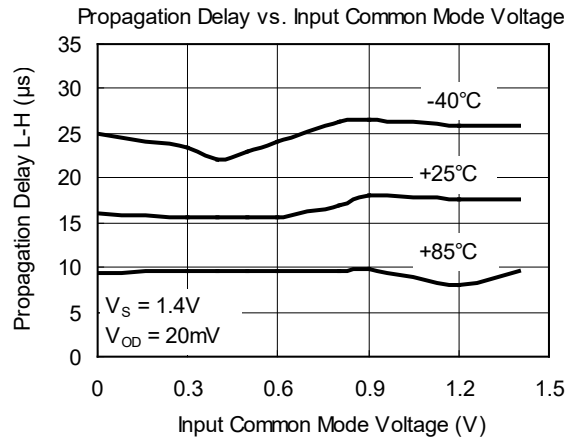
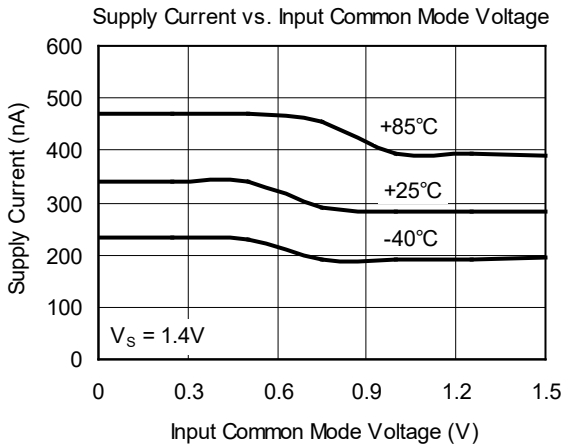

TYPICAL PERFORMANCE CHARACTERISTICS (continued)

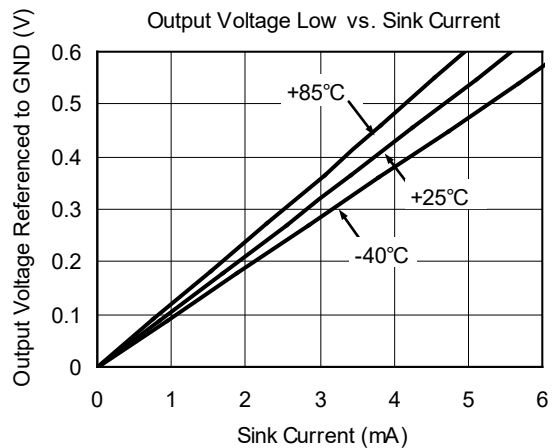
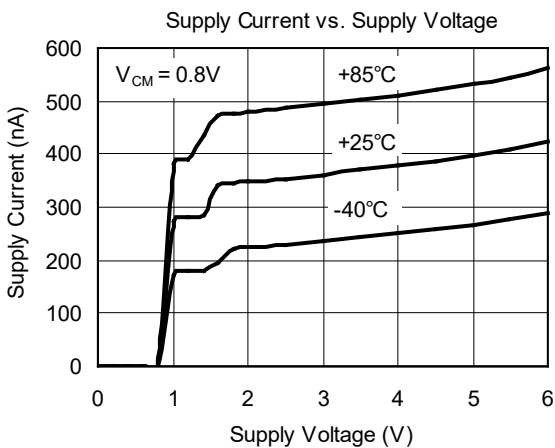
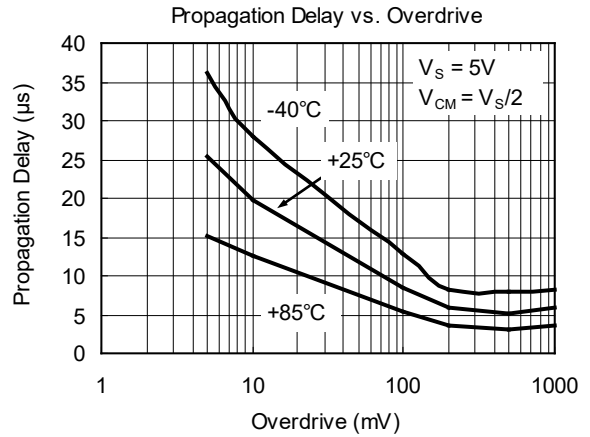
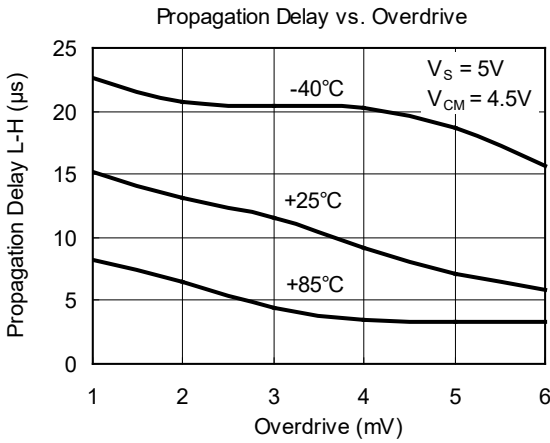
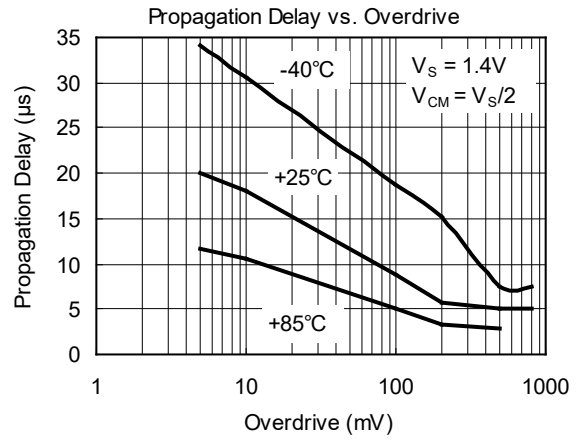
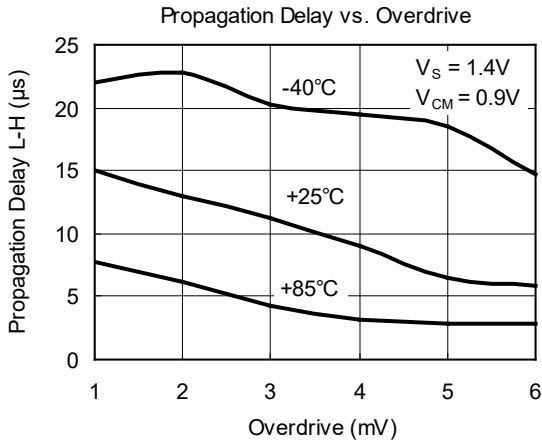

TYPICAL PERFORMANCE CHARACTERISTICS (continued)

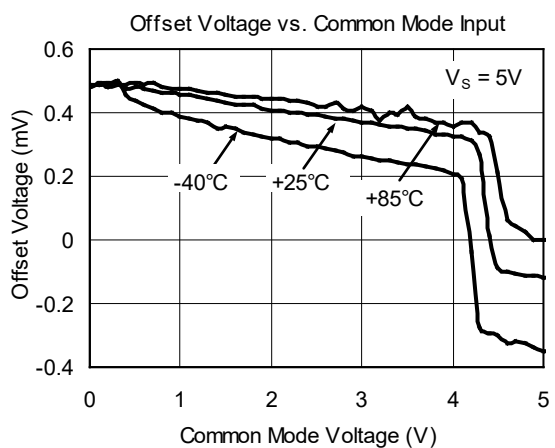
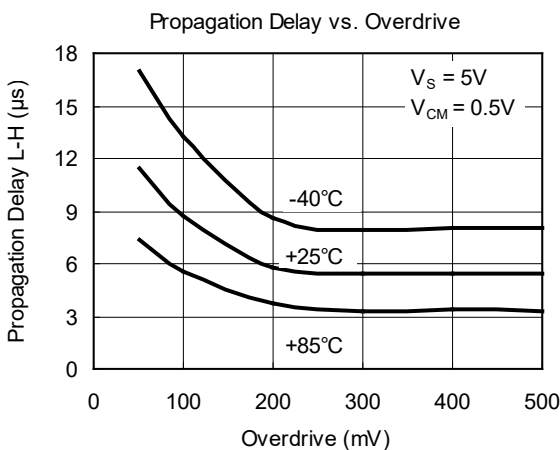
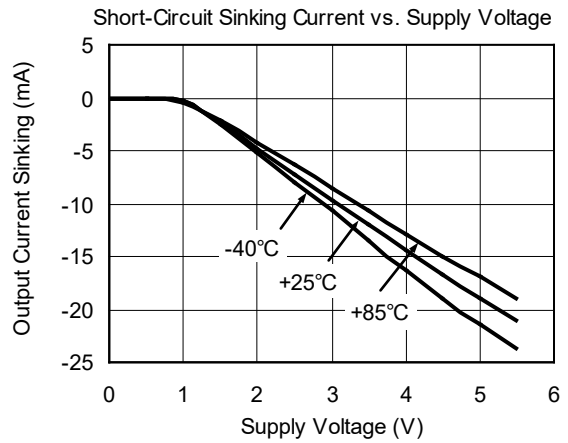
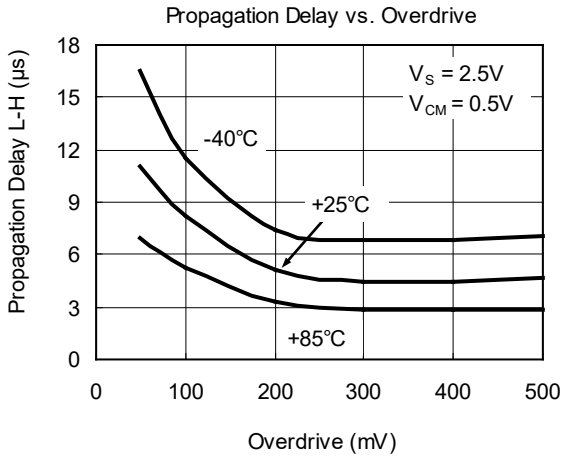
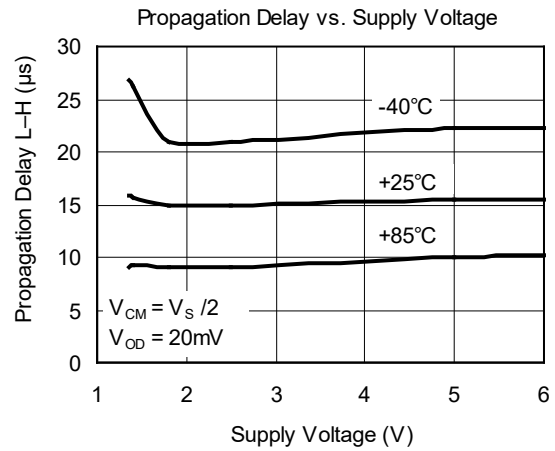
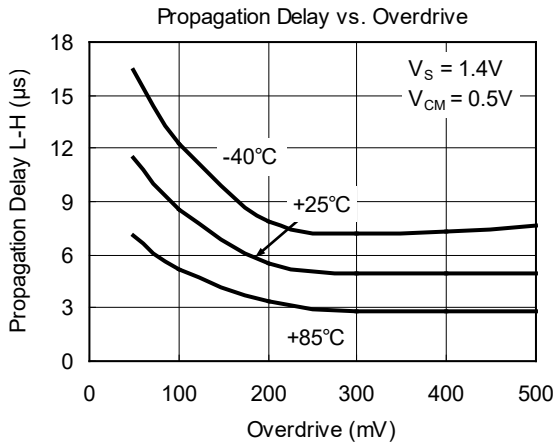

REVISION HISTORY

NOTE: Page numbers for previous revisions may differ from page numbers in the current version.

NOVEMBER 2013 – REV.A.1 to REV.A.2	Page
Changed Electrical Characteristics section	4

APRIL 2013 – REV.A to REV.A.1	Page
Added Absolute Maximum Ratings section	2

Changes from Original (SEPTEMBER 2012) to REV.A	Page
Changed from product preview to production data	All

PACKAGE INFORMATION

PACKAGE OUTLINE DIMENSIONS

SOT-23-5

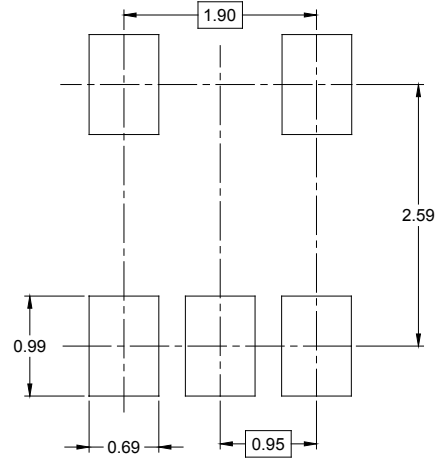
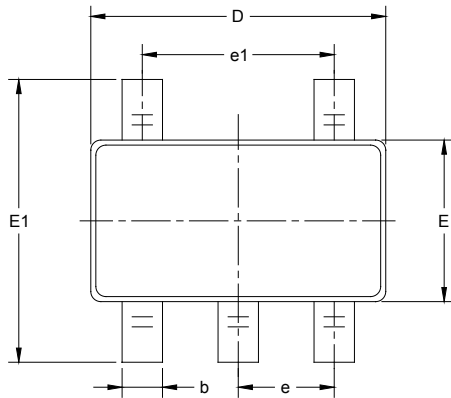

RECOMMENDED LAND PATTERN (Unit: mm)

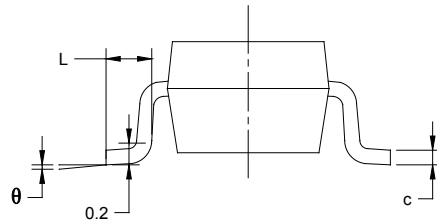
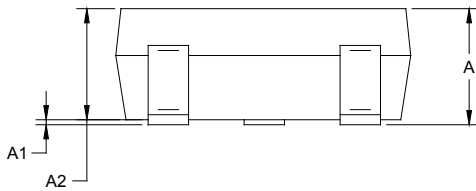

Symbol	Dimensions In Millimeters		Dimensions In Inches	
	MIN	MAX	MIN	MAX
A	1.050	1.250	0.041	0.049
A1	0.000	0.100	0.000	0.004
A2	1.050	1.150	0.041	0.045
b	0.300	0.500	0.012	0.020
c	0.100	0.200	0.004	0.008
D	2.820	3.020	0.111	0.119
E	1.500	1.700	0.059	0.067
E1	2.650	2.950	0.104	0.116
e	0.950 BSC		0.037 BSC	
e1	1.900 BSC		0.075 BSC	
L	0.300	0.600	0.012	0.024
θ	0°	8°	0°	8°

PACKAGE OUTLINE DIMENSIONS

SC70-5

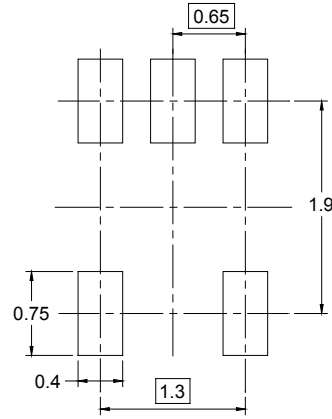
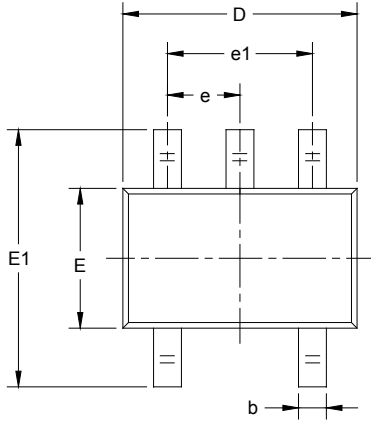

RECOMMENDED LAND PATTERN (Unit: mm)

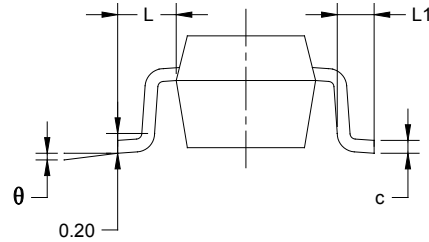
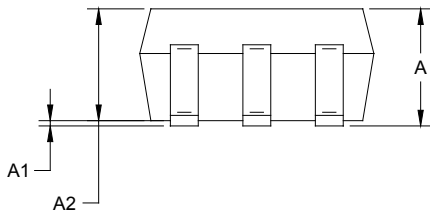

Symbol	Dimensions In Millimeters		Dimensions In Inches	
	MIN	MAX	MIN	MAX
A	0.900	1.100	0.035	0.043
A1	0.000	0.100	0.000	0.004
A2	0.900	1.000	0.035	0.039
b	0.150	0.350	0.006	0.014
c	0.080	0.150	0.003	0.006
D	2.000	2.200	0.079	0.087
E	1.150	1.350	0.045	0.053
E1	2.150	2.450	0.085	0.096
e	0.65 TYP		0.026 TYP	
e1	1.300 BSC		0.051 BSC	
L	0.525 REF		0.021 REF	
L1	0.260	0.460	0.010	0.018
θ	0°	8°	0°	8°

TAPE AND REEL INFORMATION

REEL DIMENSIONS

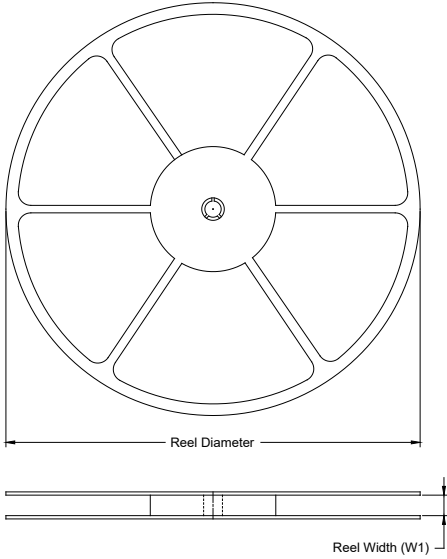

TAPE DIMENSIONS



NOTE: The picture is only for reference. Please make the object as the standard.

KEY PARAMETER LIST OF TAPE AND REEL

Package Type	Reel Diameter	Reel Width W1 (mm)	A0 (mm)	B0 (mm)	K0 (mm)	P0 (mm)	P1 (mm)	P2 (mm)	W (mm)	Pin1 Quadrant
SOT-23-5	7"	9.5	3.20	3.20	1.40	4.0	4.0	2.0	8.0	Q3
SC70-5	7"	9.5	2.25	2.55	1.20	4.0	4.0	2.0	8.0	Q3

DD0001

PACKAGE INFORMATION

CARTON BOX DIMENSIONS



NOTE: The picture is only for reference. Please make the object as the standard.

KEY PARAMETER LIST OF CARTON BOX

Reel Type	Length (mm)	Width (mm)	Height (mm)	Pizza/Carton
7" (Option)	368	227	224	8
7"	442	410	224	18

DD0002