



SGM8708

Micro-Power, RRIO, 1.8V, Dual Push-Pull Output Comparator with Integrated Voltage Reference

GENERAL DESCRIPTION

The SGM8708 is a low power comparator with a typical power supply current of 2.2 μ A. It features an uncommitted on-chip voltage reference, comparator input common mode range of 200mV beyond the supply rails, and single-supply operation from 1.8V to 5.5V. The integrated 1.2V series voltage reference offers low 42 μ V/ $^{\circ}$ C drift, is stable with up to 10nF capacitive load, and can source up to 2mA (TYP) of output current.

Designed to operate over a wide range of supply voltages, from 1.8V to 5.5V, with guaranteed operation at 1.8V and 5.0V, the SGM8708 is ideal for use in a variety of battery-powered applications. With rail-to-rail input common mode voltage range, the SGM8708 is well suited for single-supply operation. Its small packages make this device ideal for use in handheld electronics and mobile phone applications.

Featuring a push-pull output stage and having a latch enable input (\overline{LE}), the SGM8708 allows for operation with absolute minimum power consumption when driving any capacitive or resistive load.

SGM8708 is available in Green SOT-23-8 and SOIC-8 packages. It is rated over the -40 $^{\circ}$ C to +85 $^{\circ}$ C temperature range.

FEATURES

- **Low Power Consumption:**
2.2 μ A (TYP) at $V_S = 1.8V$
- **Wide Supply Voltage Range: 1.8V to 5.5V**
- **Push-Pull Output Current Drive:**
18mA (TYP) at $V_S = 5V$
- **Rail-to-Rail Input**
- **V_{OUT} and $\overline{V_{OUT}}$ Dual Outputs**
- **Latch Function Included**
- **Integrated 1.2V Voltage Reference**
- **-40 $^{\circ}$ C to +85 $^{\circ}$ C Operating Temperature Range**
- **Available in Green SOT-23-8 and SOIC-8 Packages**

APPLICATIONS

RC Timers
Window Detectors
IR Receiver
Multivibrators
Alarm and Monitoring Circuits

Micro-Power, RRIO, 1.8V, Dual Push-Pull Output SGM8708 Comparator with Integrated Voltage Reference

PACKAGE/ORDERING INFORMATION

MODEL	PACKAGE DESCRIPTION	SPECIFIED TEMPERATURE RANGE	ORDERING NUMBER	PACKAGE MARKING	PACKING OPTION
SGM8708	SOT-23-8	-40°C to +85°C	SGM8708YN8G/TR	SH7XX	Tape and Reel, 3000
	SOIC-8	-40°C to +85°C	SGM8708YS8G/TR	SGM 8708YS8 XXXXX	Tape and Reel, 2500

MARKING INFORMATION

NOTE: XX = Date Code. XXXXX = Date Code and Vendor Code.

SOT-23-8

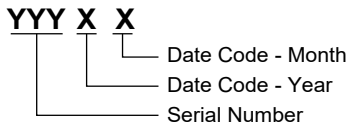

SOIC-8

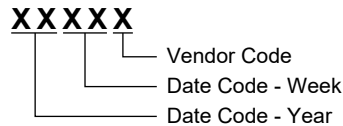

Green (RoHS & HSF): SG Micro Corp defines "Green" to mean Pb-Free (RoHS compatible) and free of halogen substances. If you have additional comments or questions, please contact your SGMICRO representative directly.

ABSOLUTE MAXIMUM RATINGS

Supply Voltage, +V _S to -V _S	6V
V _{IN} Differential	±(+V _S - (-V _S))
Voltage at Input/Output Pins	(-V _S) - 0.3V to (+V _S) + 0.3V
Junction Temperature	+150°C
Storage Temperature Range	-65°C to +150°C
Lead Temperature (Soldering, 10s)	+260°C
ESD Susceptibility	
HBM	4000V
MM	400V

RECOMMENDED OPERATING CONDITIONS

Operating Temperature Range	-40°C to +85°C
-----------------------------------	----------------

OVERSTRESS CAUTION

Stresses beyond those listed in Absolute Maximum Ratings may cause permanent damage to the device. Exposure to absolute maximum rating conditions for extended periods may affect reliability. Functional operation of the device at any conditions beyond those indicated in the Recommended Operating Conditions section is not implied.

ESD SENSITIVITY CAUTION

This integrated circuit can be damaged by ESD if you don't pay attention to ESD protection. SGMICRO recommends that all integrated circuits be handled with appropriate precautions. Failure to observe proper handling and installation procedures can cause damage. ESD damage can range from subtle performance degradation to complete device failure. Precision integrated circuits may be more susceptible to damage because very small parametric changes could cause the device not to meet its published specifications.

DISCLAIMER

SG Micro Corp reserves the right to make any change in circuit design, or specifications without prior notice.

PIN CONFIGURATIONS

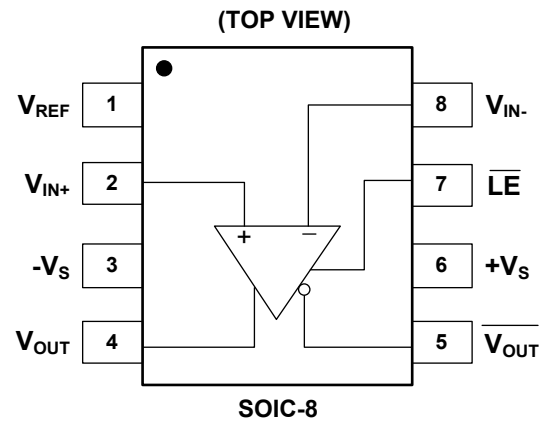
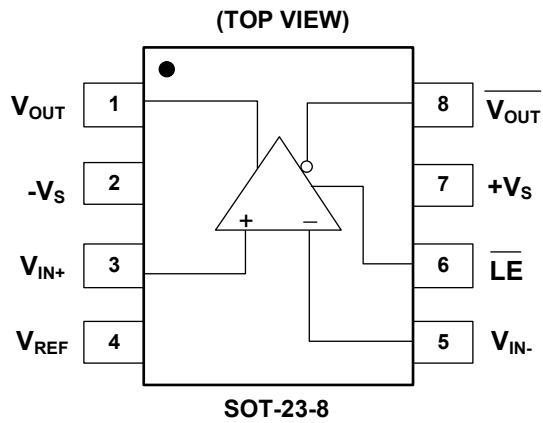

SGM8708

Micro-Power, RRIO, 1.8V, Dual Push-Pull Output Comparator with Integrated Voltage Reference

ELECTRICAL CHARACTERISTICS

(At $T_A = +25^\circ\text{C}$, $+V_S = 1.8\text{V}$, $-V_S = 0\text{V}$, $V_{\overline{\text{LE}}} = 1.8\text{V}$, $V_{\text{CM}} = +V_S/2$, unless otherwise noted.)

PARAMETER	SYMBOL	CONDITIONS	MIN	TYP	MAX	UNITS	
Supply Current	I_S	$I_{\text{OUT}} = 0$		2.2	3.8	μA	
Input Offset Voltage	V_{OS}	$V_{\text{CM}} = 0\text{V}$		0.5	3	mV	
		$V_{\text{CM}} = 1.8\text{V}$		0.5	3		
Input Offset Average Drift				2		$\mu\text{V}/^\circ\text{C}$	
Common Mode Rejection Ratio	CMRR	$V_{\text{CM}} = 0\text{V}$ to 1.8V	55	68		dB	
Power Supply Rejection Ratio	PSRR	$V_S = 1.8\text{V}$ to 5.5V , $V_{\text{CM}} = 0\text{V}$	74	102		dB	
Power Supply Ramp-Up Rate ⁽¹⁾			5			V/s	
Latch Enable Pin High Input Voltage	V_{IH}		1.0			V	
Latch Enable Pin Low Input Voltage	V_{IL}				0.25	V	
Latch Enable Pin Bias Current	$I_{\text{IH}}, I_{\text{IL}}$	$V_{\overline{\text{LE}}} = 0\text{V}$ or $V_{\overline{\text{LE}}} = 1.8\text{V}$, $V_{\text{CM}} = 0\text{V}$		3		nA	
Large Signal Voltage Gain	A_{VO}			100		dB	
Output Swing High	V_{OH}	$V_{\text{OUT}}, \overline{V_{\text{OUT}}}$	$I_{\text{OUT}} = 500\mu\text{A}$	1.617	1.675	V	
			$I_{\text{OUT}} = 500\mu\text{A}$, $-40^\circ\text{C} \leq T_A \leq +85^\circ\text{C}$	1.572			
			$I_{\text{OUT}} = 1\text{mA}$	1.412	1.525		
			$I_{\text{OUT}} = 1\text{mA}$, $-40^\circ\text{C} \leq T_A \leq +85^\circ\text{C}$	1.330			
Output Swing Low	V_{OL}	$V_{\text{OUT}}, \overline{V_{\text{OUT}}}$	$I_{\text{OUT}} = -500\mu\text{A}$		84	mV	
			$I_{\text{OUT}} = -500\mu\text{A}$, $-40^\circ\text{C} \leq T_A \leq +85^\circ\text{C}$				163
			$I_{\text{OUT}} = -1\text{mA}$		173		249
			$I_{\text{OUT}} = -1\text{mA}$, $-40^\circ\text{C} \leq T_A \leq +85^\circ\text{C}$				347
Output Current	I_{OUT}	$V_{\text{OUT}}, \overline{V_{\text{OUT}}}$	Source	1.15	2	mA	
			Source, $-40^\circ\text{C} \leq T_A \leq +85^\circ\text{C}$	1.0			
			Sink		-3.5		-2.0
			Sink, $-40^\circ\text{C} \leq T_A \leq +85^\circ\text{C}$				-1.4
Propagation Delay (High to Low)		$V_{\text{OUT}}, \overline{V_{\text{OUT}}}$	Overdrive = 10mV		11.7	μs	
			Overdrive = 100mV		5.6		
Propagation Delay (Low to High)		$V_{\text{OUT}}, \overline{V_{\text{OUT}}}$	Overdrive = 10mV		24.2	μs	
			Overdrive = 100mV		14.7		
Rise Time	t_{RISE}	$V_{\text{OUT}}, \overline{V_{\text{OUT}}}$	Overdrive = 10mV, $C_L = 30\text{pF}$, $R_L = 1\text{M}\Omega$		168	ns	
			Overdrive = 100mV, $C_L = 30\text{pF}$, $R_L = 1\text{M}\Omega$		174		
Fall Time	t_{FALL}	$V_{\text{OUT}}, \overline{V_{\text{OUT}}}$	Overdrive = 10mV, $C_L = 30\text{pF}$, $R_L = 1\text{M}\Omega$		75	ns	
			Overdrive = 100mV, $C_L = 30\text{pF}$, $R_L = 1\text{M}\Omega$		50		
Noise of V_{REF}			$f = 0.1\text{Hz}$ to 10Hz		0.3	mV _{p-p}	
Voltage Reference							
Reference Voltage	V_{REF}	$I_{\text{REF}} = 0\text{mA}$		1.182	1.200	1.218	V
Reference Voltage Drift					42		$\mu\text{V}/^\circ\text{C}$
Reference Output Current (Source)					2		mA

SGM8708

Micro-Power, RRIO, 1.8V, Dual Push-Pull Output Comparator with Integrated Voltage Reference

ELECTRICAL CHARACTERISTICS (continued)

(At $T_A = +25^\circ\text{C}$, $+V_S = 5\text{V}$, $-V_S = 0\text{V}$, $V_{\overline{\text{LE}}} = 5\text{V}$, $V_{\text{CM}} = +V_S/2$, unless otherwise noted.)

PARAMETER	SYMBOL	CONDITIONS	MIN	TYP	MAX	UNITS	
Supply Current	I_S	$I_{\text{OUT}} = 0$		2.3	3.9	μA	
Input Offset Voltage	V_{OS}	$V_{\text{CM}} = 0\text{V}$		0.5	3	mV	
		$V_{\text{CM}} = 5\text{V}$		0.5	3		
Input Offset Average Drift				2		$\mu\text{V}/^\circ\text{C}$	
Common Mode Rejection Ratio	CMRR	$V_{\text{CM}} = 0\text{V}$ to 5V	63	76		dB	
Power Supply Rejection Ratio	PSRR	$V_S = 1.8\text{V}$ to 5.5V , $V_{\text{CM}} = 0\text{V}$	74	102		dB	
Power Supply Ramp-Up Rate ⁽¹⁾			5			V/s	
Latch Enable Pin High Input Voltage	V_{IH}		2			V	
Latch Enable Pin Low Input Voltage	V_{IL}				0.8	V	
Latch Enable Pin Bias Current	$I_{\text{IH}}, I_{\text{IL}}$	$V_{\overline{\text{LE}}} = 0\text{V}$ or $V_{\overline{\text{LE}}} = 5\text{V}$, $V_{\text{CM}} = 0\text{V}$		60		nA	
Latch Propagation Delay	t_{LPD}	$V_S = 3\text{V}$		90		ns	
Large Signal Voltage Gain	A_{VO}			110		dB	
Output Swing High	V_{OH}	$V_{\text{OUT}}, \overline{V_{\text{OUT}}}$	$I_{\text{OUT}} = 500\mu\text{A}$	4.935	4.952	V	
			$I_{\text{OUT}} = 500\mu\text{A}$, $-40^\circ\text{C} \leq T_A \leq +85^\circ\text{C}$	4.926			
			$I_{\text{OUT}} = 1\text{mA}$	4.874	4.904		
			$I_{\text{OUT}} = 1\text{mA}$, $-40^\circ\text{C} \leq T_A \leq +85^\circ\text{C}$	4.855			
Output Swing Low	V_{OL}	$V_{\text{OUT}}, \overline{V_{\text{OUT}}}$	$I_{\text{OUT}} = -500\mu\text{A}$		54	72	mV
			$I_{\text{OUT}} = -500\mu\text{A}$, $-40^\circ\text{C} \leq T_A \leq +85^\circ\text{C}$			79	
			$I_{\text{OUT}} = -1\text{mA}$		106	140	
			$I_{\text{OUT}} = -1\text{mA}$, $-40^\circ\text{C} \leq T_A \leq +85^\circ\text{C}$			154	
Output Current	I_{OUT}	$V_{\text{OUT}}, \overline{V_{\text{OUT}}}$	Source	14.0	18	mA	
			Source, $-40^\circ\text{C} \leq T_A \leq +85^\circ\text{C}$	10.5			
			Sink		-18		-15.5
			Sink, $-40^\circ\text{C} \leq T_A \leq +85^\circ\text{C}$				-12.5
Propagation Delay (High to Low)		$V_{\text{OUT}}, \overline{V_{\text{OUT}}}$	Overdrive = 10mV		12.7	μs	
			Overdrive = 100mV		5.6		
Propagation Delay (Low to High)		$V_{\text{OUT}}, \overline{V_{\text{OUT}}}$	Overdrive = 10mV		38.1	μs	
			Overdrive = 100mV		29.5		
Rise Time	t_{RISE}	$V_{\text{OUT}}, \overline{V_{\text{OUT}}}$	Overdrive = 10mV, $C_L = 30\text{pF}$, $R_L = 1\text{M}\Omega$		39	ns	
			Overdrive = 100mV, $C_L = 30\text{pF}$, $R_L = 1\text{M}\Omega$		40		
Fall Time	t_{FALL}	$V_{\text{OUT}}, \overline{V_{\text{OUT}}}$	Overdrive = 10mV, $C_L = 30\text{pF}$, $R_L = 1\text{M}\Omega$		33	ns	
			Overdrive = 100mV, $C_L = 30\text{pF}$, $R_L = 1\text{M}\Omega$		30		
Noise of V_{REF}			$f = 0.1\text{Hz}$ to 10Hz		0.32	$\text{mV}_{\text{P-P}}$	
Voltage Reference							
Reference Voltage	V_{REF}	$I_{\text{REF}} = 0\text{mA}$	1.182	1.200	1.218	V	
Reference Voltage Drift				41		$\mu\text{V}/^\circ\text{C}$	
Reference Output Current (Source)				2		mA	

NOTE:

1. If the power supply ramp-up rate is lower than 5V/s, the reference voltage output is not guaranteed to start up.

SGM8708 Micro-Power, RRIO, 1.8V, Dual Push-Pull Output Comparator with Integrated Voltage Reference

TYPICAL PERFORMANCE CHARACTERISTICS

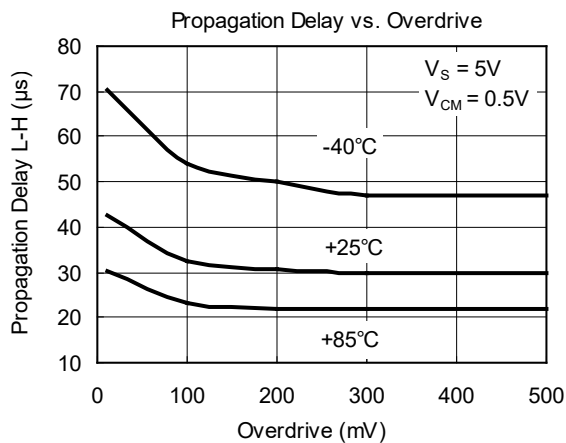
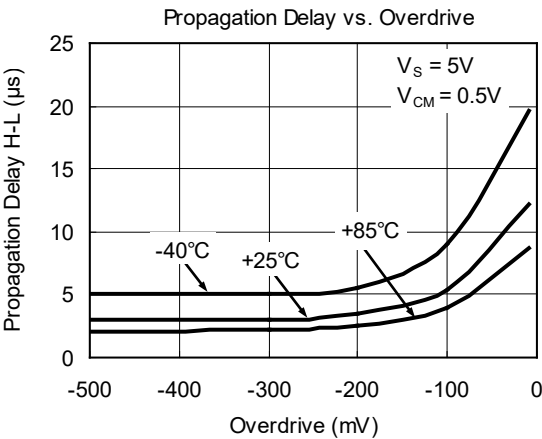
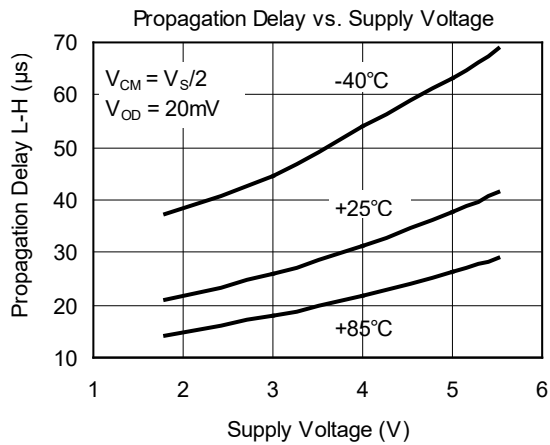
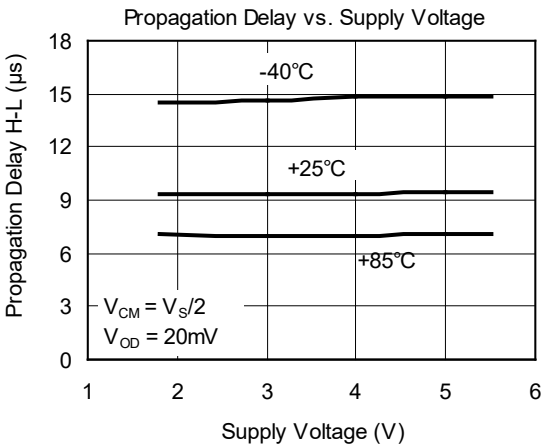
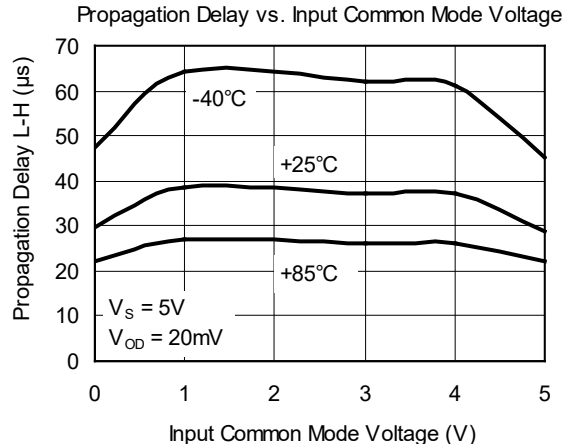
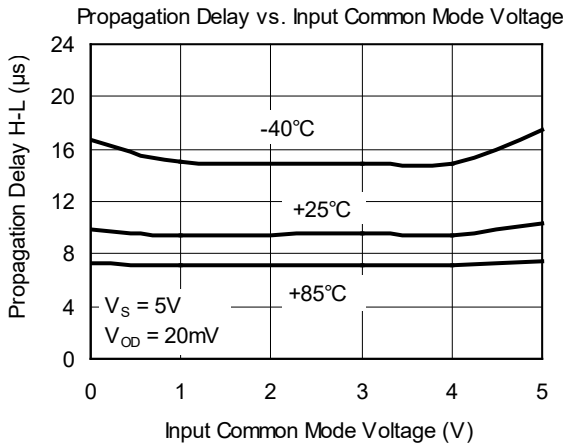

SGM8708 Micro-Power, RRIO, 1.8V, Dual Push-Pull Output Comparator with Integrated Voltage Reference

TYPICAL PERFORMANCE CHARACTERISTICS (continued)

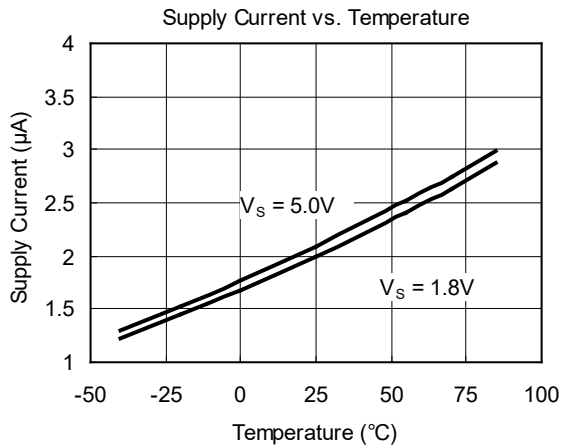
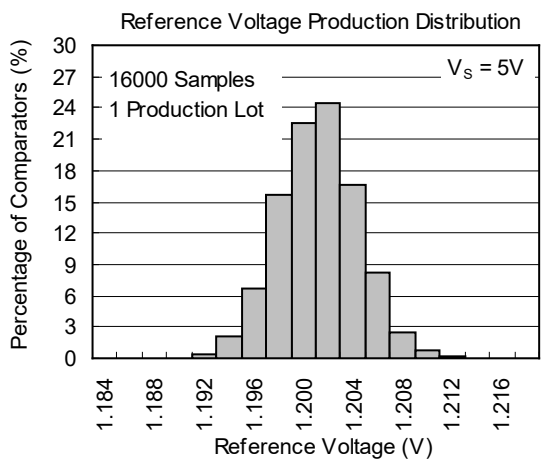
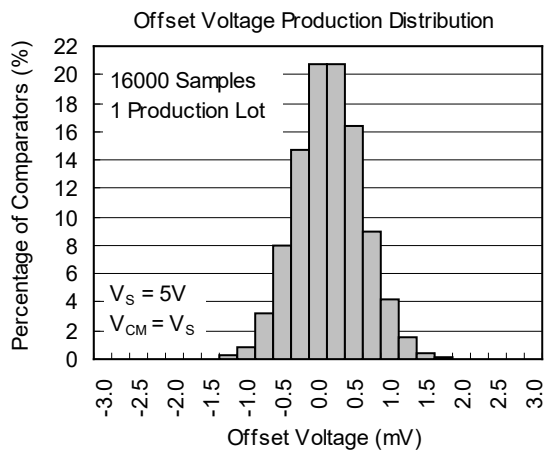
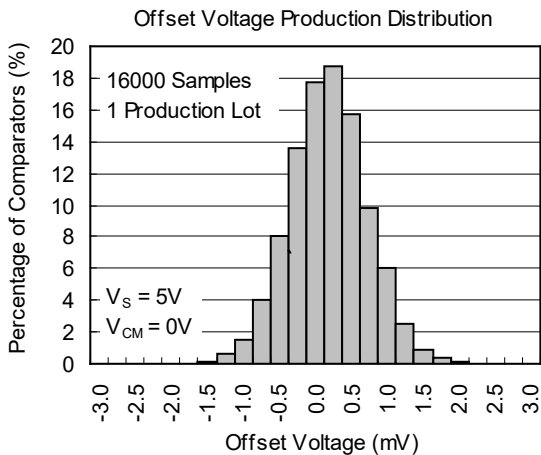
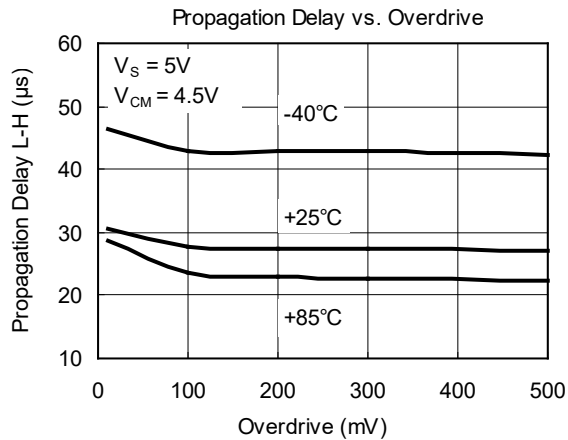
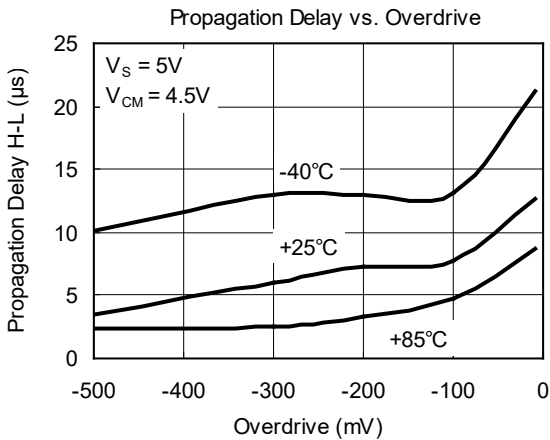

TYPICAL PERFORMANCE CHARACTERISTICS (continued)

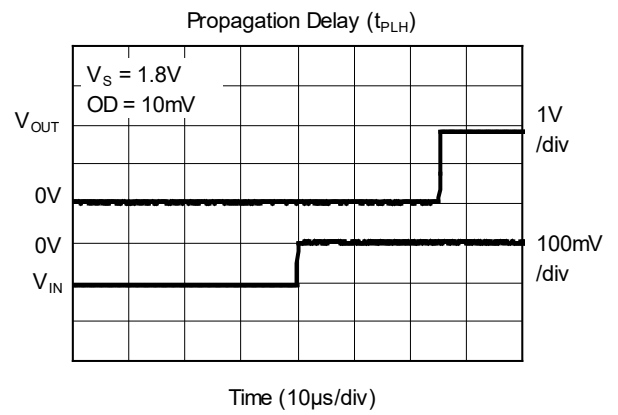
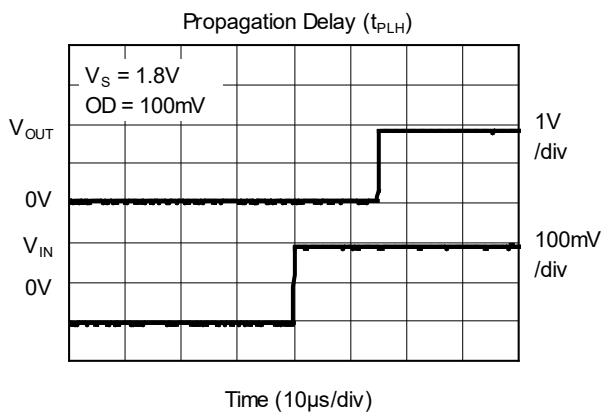
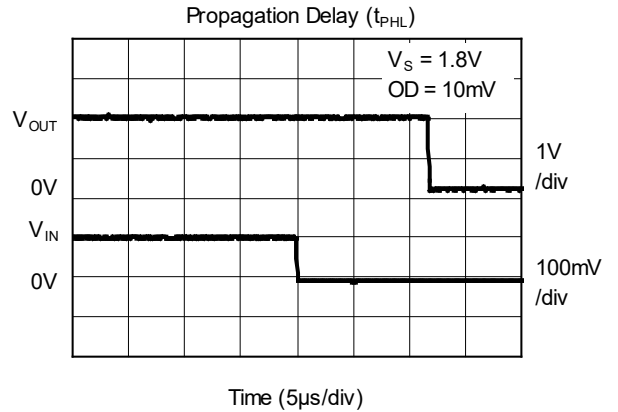
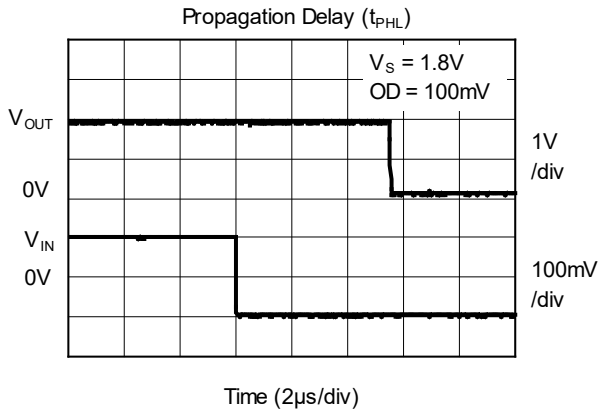
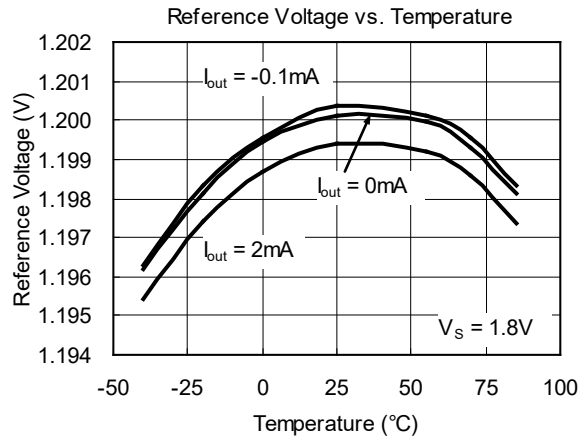
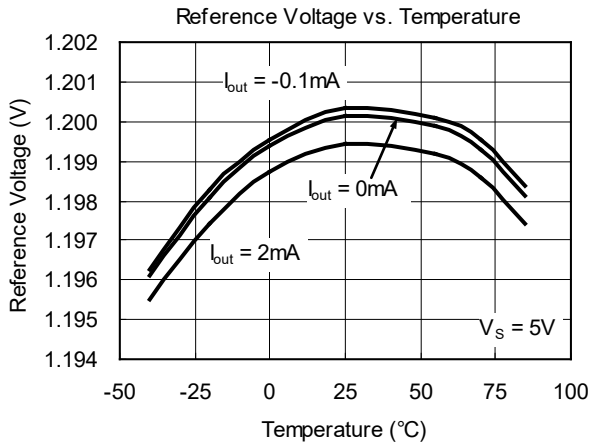

TYPICAL PERFORMANCE CHARACTERISTICS (continued)

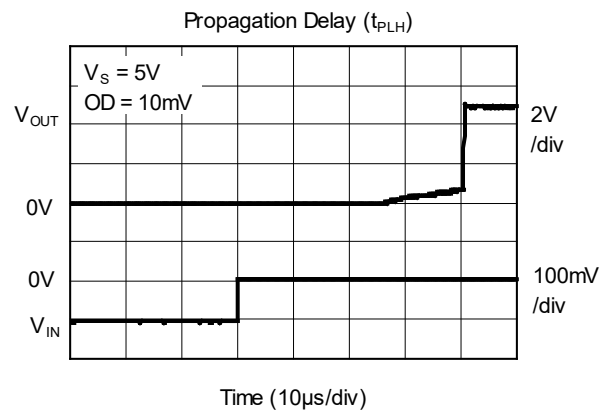
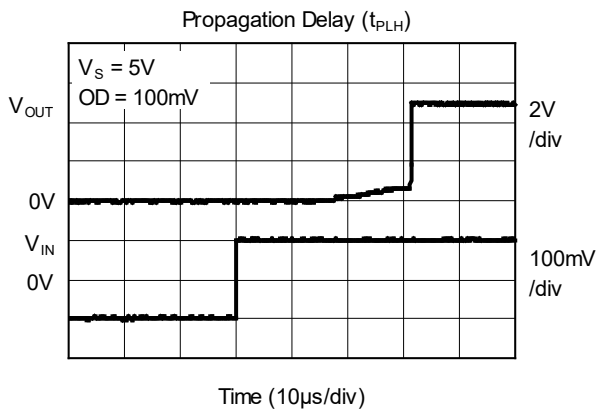
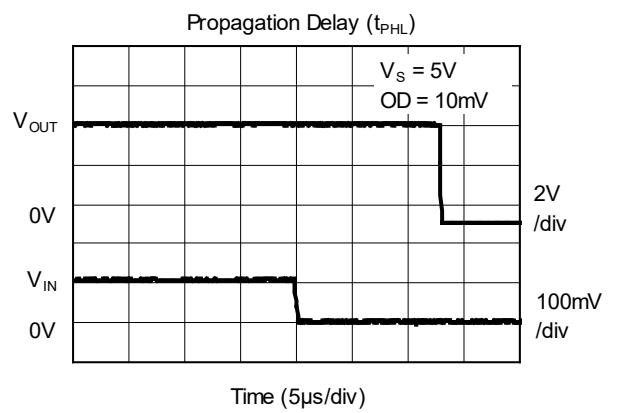
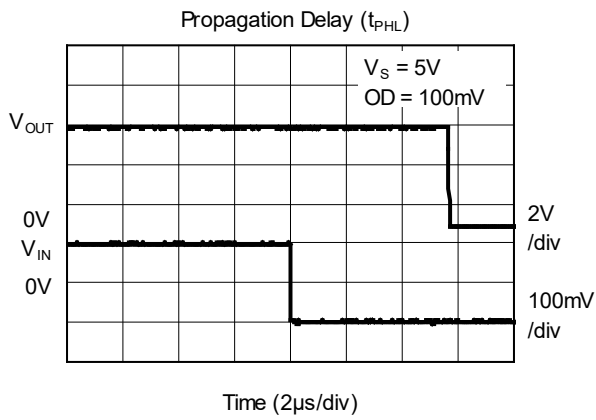

TIMING DIAGRAM

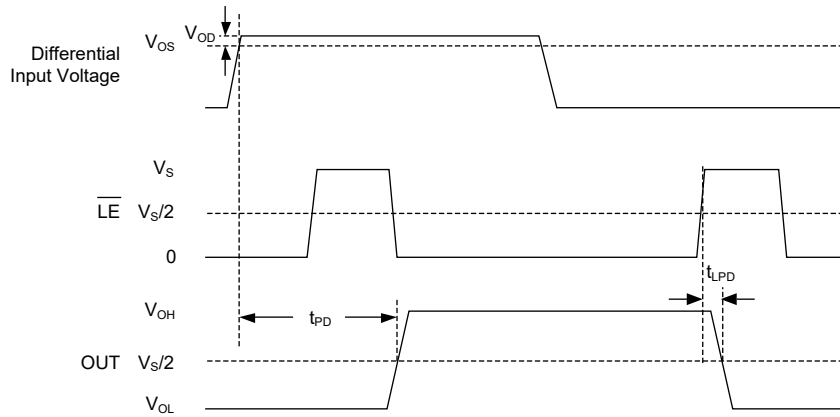

Figure 1. Timing Diagram with Latch Operator

REVISION HISTORY

NOTE: Page numbers for previous revisions may differ from page numbers in the current version.

DECEMBER 2013 – REV.A to REV.A.1	Page
Added Electrical Characteristics section	4
Added Timing Diagram section	9

Changes from Original (NOVEMBER 2012) to REV.A	Page
Changed from product preview to production data	All

PACKAGE OUTLINE DIMENSIONS

SOT-23-8

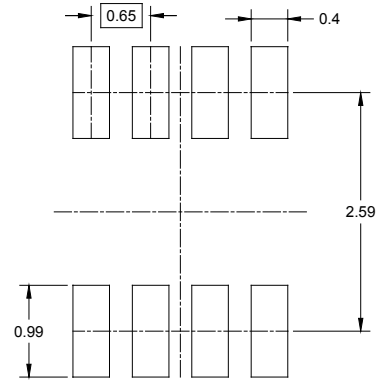
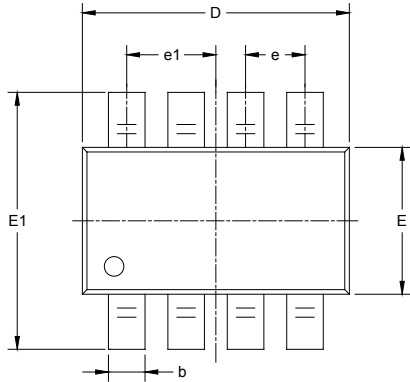

RECOMMENDED LAND PATTERN (Unit: mm)

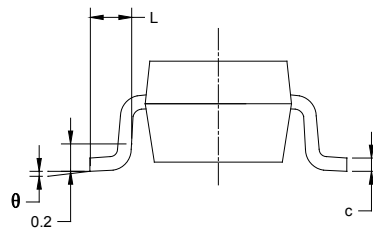
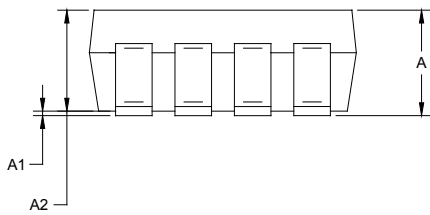

Symbol	Dimensions In Millimeters		Dimensions In Inches	
	MIN	MAX	MIN	MAX
A	1.050	1.250	0.041	0.049
A1	0.000	0.100	0.000	0.004
A2	1.050	1.150	0.041	0.045
b	0.300	0.500	0.012	0.020
c	0.100	0.200	0.004	0.008
D	2.820	3.020	0.111	0.119
E	1.500	1.700	0.059	0.067
E1	2.650	2.950	0.104	0.116
e	0.650 BSC		0.026 BSC	
e1	0.975 BSC		0.038 BSC	
L	0.300	0.600	0.012	0.024
θ	0°	8°	0°	8°

PACKAGE OUTLINE DIMENSIONS

SOIC-8

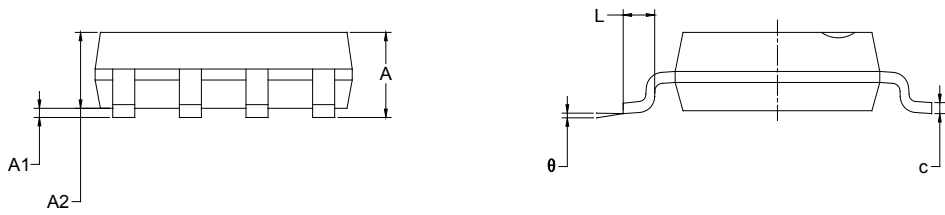
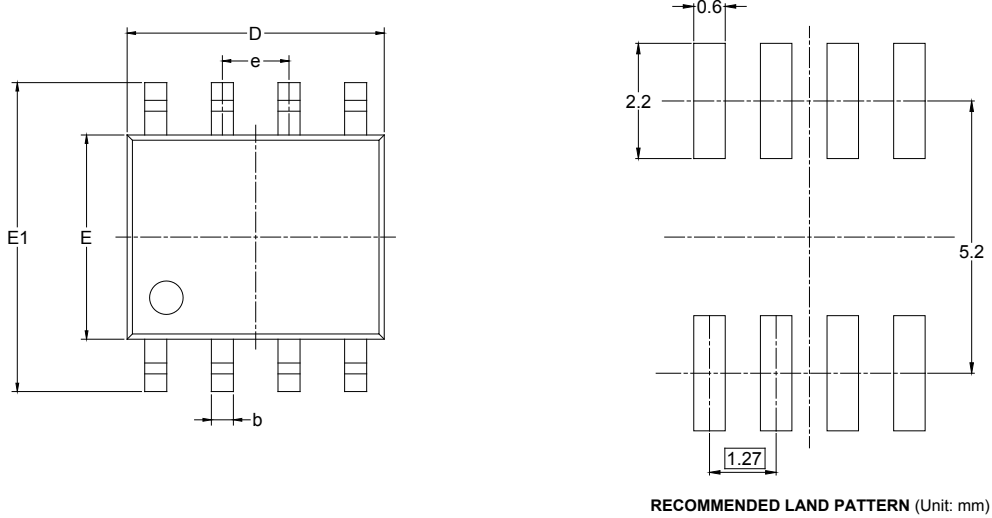

Symbol	Dimensions In Millimeters		Dimensions In Inches	
	MIN	MAX	MIN	MAX
A	1.350	1.750	0.053	0.069
A1	0.100	0.250	0.004	0.010
A2	1.350	1.550	0.053	0.061
b	0.330	0.510	0.013	0.020
c	0.170	0.250	0.006	0.010
D	4.700	5.100	0.185	0.200
E	3.800	4.000	0.150	0.157
E1	5.800	6.200	0.228	0.244
e	1.27 BSC		0.050 BSC	
L	0.400	1.270	0.016	0.050
θ	0°	8°	0°	8°

TAPE AND REEL INFORMATION

REEL DIMENSIONS



TAPE DIMENSIONS



NOTE: The picture is only for reference. Please make the object as the standard.

KEY PARAMETER LIST OF TAPE AND REEL

Package Type	Reel Diameter	Reel Width W1 (mm)	A0 (mm)	B0 (mm)	K0 (mm)	P0 (mm)	P1 (mm)	P2 (mm)	W (mm)	Pin1 Quadrant
SOT-23-8	7"	9.5	3.17	3.23	1.37	4.0	4.0	2.0	8.0	Q3
SOIC-8	13"	12.4	6.40	5.40	2.10	4.0	8.0	2.0	12.0	Q1

000001

PACKAGE INFORMATION

CARTON BOX DIMENSIONS



NOTE: The picture is only for reference. Please make the object as the standard.

KEY PARAMETER LIST OF CARTON BOX

Reel Type	Length (mm)	Width (mm)	Height (mm)	Pizza/Carton
7" (Option)	368	227	224	8
7"	442	410	224	18
13"	386	280	370	5

DD0002