



# SGM8704

## Micro-Power, CMOS Input, RRIO, 1.4V, Push-Pull Output Comparator

---

### GENERAL DESCRIPTION

The SGM8704 is an ultra low power comparator with a typical power supply current of 300nA. It has the best-in-class power supply current versus propagation delay performance. The propagation delay is as low as 6 $\mu$ s with 100mV overdrive at 1.4V supply.

Designed to operate over a wide range of supply voltages, from 1.4V to 5.5V, with guaranteed operation at 1.4V, 2.5V and 5.0V, the SGM8704 is ideal for use in a variety of battery-powered applications. With rail-to-rail common mode voltage range, the SGM8704 is well suited for single-supply operation. The SGM8704 features complementary outputs and has a latch enable input ( $\overline{LE}$ ). Its small packages make this device ideal for use in handheld electronics and mobile phone applications.

Featuring a push-pull output stage, the SGM8704 allows for operation with absolute minimum power consumption when driving any capacitive or resistive load.

SGM8704 is available in Green SOIC-8 and MSOP-8 packages. It is rated over the -40°C to +85°C temperature range.

### FEATURES

- **Ultra Low Power Consumption:**  
300nA (TYP) at  $V_S = 1.4V$
- **Wide Supply Voltage Range: 1.4V to 5.5V**
- **Propagation Delay: 6 $\mu$ s (TYP) at  $V_S = 1.4V$**
- **Push-Pull Output Current Drive:**  
19mA (TYP) at  $V_S = 5V$
- **Rail-to-Rail Input**
- **Latch Function Included**
- **-40°C to +85°C Operating Temperature Range**
- **Available in Green SOIC-8 and MSOP-8 Packages**

### APPLICATIONS

RC Timers  
Window Detectors  
IR Receiver  
Multivibrators  
Alarm and Monitoring Circuits

**PACKAGE/ORDERING INFORMATION**

MODEL	PACKAGE DESCRIPTION	SPECIFIED TEMPERATURE RANGE	ORDERING NUMBER	PACKAGE MARKING	PACKING OPTION
SGM8704	SOIC-8	-40°C to +85°C	SGM8704YS8G/TR	SGM8704YS8 XXXXX	Tape and Reel, 2500
	MSOP-8	-40°C to +85°C	SGM8704YMS8G/TR	SGM8704 YMS8 XXXXX	Tape and Reel, 3000

**MARKING INFORMATION**

NOTE: XXXXX = Date Code and Vendor Code.

**SOIC-8/MSOP-8**

**XXXXX**

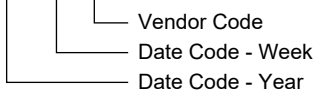

Green (RoHS & HSF): SG Micro Corp defines "Green" to mean Pb-Free (RoHS compatible) and free of halogen substances. If you have additional comments or questions, please contact your SGMICRO representative directly.

**ABSOLUTE MAXIMUM RATINGS**

Supply Voltage, +V <sub>S</sub> to -V <sub>S</sub> .....	6V
V <sub>IN</sub> Differential .....	±2.5V
Voltage at Input/Output Pins .....	(-V <sub>S</sub> ) - 0.3V to (+V <sub>S</sub> ) + 0.3V
Junction Temperature .....	+150°C
Storage Temperature Range .....	-65°C to +150°C
Lead Temperature (Soldering, 10s) .....	+260°C
ESD Susceptibility	
HBM .....	3000V
MM .....	300V

can cause damage. ESD damage can range from subtle performance degradation to complete device failure. Precision integrated circuits may be more susceptible to damage because very small parametric changes could cause the device not to meet its published specifications.

**RECOMMENDED OPERATING CONDITIONS**

Operating Temperature Range .....	-40°C to +85°C
-----------------------------------	----------------

**DISCLAIMER**

SG Micro Corp reserves the right to make any change in circuit design, or specifications without prior notice.

**OVERSTRESS CAUTION**

Stresses beyond those listed in Absolute Maximum Ratings may cause permanent damage to the device. Exposure to absolute maximum rating conditions for extended periods may affect reliability. Functional operation of the device at any conditions beyond those indicated in the Recommended Operating Conditions section is not implied.

**PIN CONFIGURATIONS**

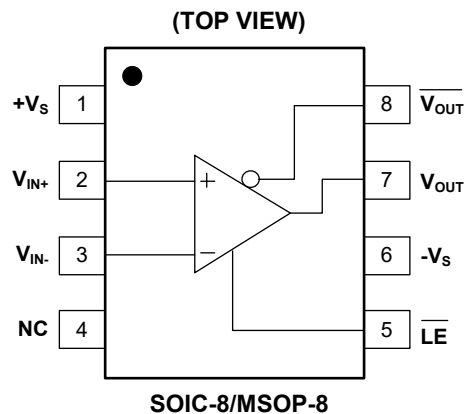

**ESD SENSITIVITY CAUTION**

This integrated circuit can be damaged by ESD if you don't pay attention to ESD protection. SGMICRO recommends that all integrated circuits be handled with appropriate precautions. Failure to observe proper handling and installation procedures

## ELECTRICAL CHARACTERISTICS

(At  $T_A = +25^\circ\text{C}$ ,  $+V_S = 1.4\text{V}$ ,  $-V_S = 0\text{V}$ ,  $V_{\overline{\text{LE}}} = 1.4\text{V}$ ,  $V_{\text{CM}} = +V_S/2$  and  $V_{\text{OUT}} = -V_S$ , unless otherwise noted.)

PARAMETER	SYMBOL	CONDITIONS		MIN	TYP	MAX	UNITS
Supply Current	$I_S$	$V_{\text{CM}} = 0.3\text{V}$			300	1000	nA
		$V_{\text{CM}} = 1.1\text{V}$			250	1000	
Input Offset Voltage	$V_{\text{OS}}$	$V_{\text{CM}} = 0\text{V}$		-3	0.5	3	mV
		$V_{\text{CM}} = 1.4\text{V}$		-3	0.5	3	
Input Offset Average Drift					2		$\mu\text{V}/^\circ\text{C}$
Common Mode Rejection Ratio	CMRR	$V_{\text{CM}}$ Stepped from 0V to 0.3V			65		dB
		$V_{\text{CM}}$ Stepped from 0.8V to 1.4V			75		
		$V_{\text{CM}}$ Stepped from 0V to 1.4V			75		
Power Supply Rejection Ratio	PSRR			66	95		dB
Latch Enable Pin High Input Voltage	$V_{\text{IH}}$			1.0			V
Latch Enable Pin Low Input Voltage	$V_{\text{IL}}$					0.25	V
Latch Enable Pin Bias Current	$I_{\text{IH}}, I_{\text{IL}}$	$V_{\overline{\text{LE}}} = 0\text{V}$ and $V_{\overline{\text{LE}}} = 1.4\text{V}$			3		nA
Large Signal Voltage Gain	$A_{\text{VO}}$				100		dB
Output Swing High	$V_{\text{OH}}$	$V_{\text{OUT}}, \overline{V_{\text{OUT}}}$	$V_S = 1.8\text{V}, I_{\text{OUT}} = 500\mu\text{A}$	1.598	1.669		V
			$-40^\circ\text{C} \leq T_A \leq +85^\circ\text{C}$	1.581			
			$V_S = 1.8\text{V}, I_{\text{OUT}} = 1\text{mA}$	1.324	1.508		
			$-40^\circ\text{C} \leq T_A \leq +85^\circ\text{C}$	1.288			
Output Swing Low	$V_{\text{OL}}$	$V_{\text{OUT}}, \overline{V_{\text{OUT}}}$	$V_S = 1.8\text{V}, I_{\text{OUT}} = -500\mu\text{A}$		82	112	mV
			$-40^\circ\text{C} \leq T_A \leq +85^\circ\text{C}$			127	
			$V_S = 1.8\text{V}, I_{\text{OUT}} = -1\text{mA}$		167	225	
			$-40^\circ\text{C} \leq T_A \leq +85^\circ\text{C}$			253	
Output Current	$I_{\text{OUT}}$	Source	$V_{\text{OUT}}, \overline{V_{\text{OUT}}}$		0.7		mA
		Sink	$V_{\text{OUT}}, \overline{V_{\text{OUT}}}$		2.0		
Propagation Delay (High to Low)		$V_{\text{OUT}}, \overline{V_{\text{OUT}}}$	Overdrive = 10mV		12		$\mu\text{s}$
			Overdrive = 100mV		6		
Propagation Delay (Low to High)		$V_{\text{OUT}}, \overline{V_{\text{OUT}}}$	Overdrive = 10mV		26		$\mu\text{s}$
			Overdrive = 100mV		17		
Rise Time	$t_{\text{Rise}}$	$V_{\text{OUT}}, \overline{V_{\text{OUT}}}$	Overdrive = 10mV, $C_L = 30\text{pF}, R_L = 1\text{M}\Omega$		220		ns
			Overdrive = 100mV, $C_L = 30\text{pF}, R_L = 1\text{M}\Omega$		220		
Fall Time	$t_{\text{Fall}}$	$V_{\text{OUT}}, \overline{V_{\text{OUT}}}$	Overdrive = 10mV, $C_L = 30\text{pF}, R_L = 1\text{M}\Omega$		250		ns
			Overdrive = 100mV, $C_L = 30\text{pF}, R_L = 1\text{M}\Omega$		250		

**ELECTRICAL CHARACTERISTICS (continued)**(At  $T_A = +25^\circ\text{C}$ ,  $+V_S = 2.5\text{V}$ ,  $-V_S = 0\text{V}$ ,  $V_{LE} = 2.5\text{V}$ ,  $V_{CM} = +V_S/2$  and  $V_{OUT} = -V_S$ , unless otherwise noted.)

PARAMETER	SYMBOL	CONDITIONS		MIN	TYP	MAX	UNITS
Supply Current	$I_S$	$V_{CM} = 0.3\text{V}$			310		nA
		$V_{CM} = 2.2\text{V}$			260		
Input Offset Voltage	$V_{OS}$	$V_{CM} = 0\text{V}$			0.5		mV
		$V_{CM} = 2.5\text{V}$			0.5		
Input Offset Average Drift		$V_{CM} = 0\text{V}$			2		$\mu\text{V}/^\circ\text{C}$
Common Mode Rejection Ratio	CMRR	$V_{CM}$ Stepped from 0V to 1.4V			75		dB
		$V_{CM}$ Stepped from 1.9V to 2.5V			80		
		$V_{CM}$ Stepped from 0V to 2.5V			80		
Power Supply Rejection Ratio	PSRR				95		dB
Latch Enable Pin High Input Voltage	$V_{IH}$			1.2			V
Latch Enable Pin Low Input Voltage	$V_{IL}$					0.4	V
Latch Enable Pin Bias Current	$I_{IH}, I_{IL}$	$V_{LE} = 0\text{V}$ and $V_{LE} = 2.5\text{V}$			15		nA
Large Signal Voltage Gain	$A_{VO}$				100		dB
Output Swing High	$V_{OH}$	$V_{OUT}, \overline{V_{OUT}}$	$I_{OUT} = 500\mu\text{A}$		2.419		V
			$I_{OUT} = 1\text{mA}$		2.333		
Output Swing Low	$V_{OL}$	$V_{OUT}, \overline{V_{OUT}}$	$I_{OUT} = -500\mu\text{A}$		66		mV
			$I_{OUT} = -1\text{mA}$		133		
Output Current	$I_{OUT}$	Source	$V_{OUT}, \overline{V_{OUT}}$		5.3		mA
		Sink	$V_{OUT}, \overline{V_{OUT}}$		7.7		
Propagation Delay (High to Low)		$V_{OUT}, \overline{V_{OUT}}$	Overdrive = 10mV		12		$\mu\text{s}$
			Overdrive = 100mV		5		
Propagation Delay (Low to High)		$V_{OUT}, \overline{V_{OUT}}$	Overdrive = 10mV		28		$\mu\text{s}$
			Overdrive = 100mV		19		
Rise Time	$t_{Rise}$	$V_{OUT}, \overline{V_{OUT}}$	Overdrive = 10mV, $C_L = 30\text{pF}$ , $R_L = 1\text{M}\Omega$		120		ns
			Overdrive = 100mV, $C_L = 30\text{pF}$ , $R_L = 1\text{M}\Omega$		120		
Fall Time	$t_{Fall}$	$V_{OUT}, \overline{V_{OUT}}$	Overdrive = 10mV, $C_L = 30\text{pF}$ , $R_L = 1\text{M}\Omega$		75		ns
			Overdrive = 100mV, $C_L = 30\text{pF}$ , $R_L = 1\text{M}\Omega$		75		

## ELECTRICAL CHARACTERISTICS (continued)

(At  $T_A = +25^\circ\text{C}$ ,  $+V_S = 5\text{V}$ ,  $-V_S = 0\text{V}$ ,  $V_{\overline{\text{LE}}} = 5\text{V}$ ,  $V_{\text{CM}} = +V_S/2$  and  $V_{\text{OUT}} = -V_S$ , unless otherwise noted.)

PARAMETER	SYMBOL	CONDITIONS		MIN	TYP	MAX	UNITS
Supply Current	$I_S$	$V_{\text{CM}} = 0.3\text{V}$			350	2000	nA
		$V_{\text{CM}} = 4.7\text{V}$			300	2000	
Input Offset Voltage	$V_{\text{OS}}$	$V_{\text{CM}} = 0\text{V}$		-3	0.5	3	mV
		$V_{\text{CM}} = 5\text{V}$		-3	0.5	3	
Input Offset Average Drift		$V_{\text{CM}} = 0\text{V}$			2		$\mu\text{V}/^\circ\text{C}$
Common Mode Rejection Ratio	CMRR	$V_{\text{CM}}$ Stepped from 0V to 3.9V			85		dB
		$V_{\text{CM}}$ Stepped from 4.4V to 5V			85		
		$V_{\text{CM}}$ Stepped from 0V to 5V			85		
Power Supply Rejection Ratio	PSRR			66	95		dB
Latch Enable Pin High Input Voltage	$V_{\text{IH}}$			2.0			V
Latch Enable Pin Low Input Voltage	$V_{\text{IL}}$					0.8	V
Latch Enable Pin Bias Current	$I_{\text{IH}}, I_{\text{IL}}$	$V_{\overline{\text{LE}}} = 0\text{V}$ and $V_{\overline{\text{LE}}} = 5\text{V}$			60		nA
Latch Propagation Delay	$t_{\text{LPD}}$	$V_S = 3\text{V}$			90		ns
Large Signal Voltage Gain	$A_{\text{VO}}$				105		dB
Output Swing High	$V_{\text{OH}}$	$V_{\text{OUT}}, \overline{V_{\text{OUT}}}$	$I_{\text{OUT}} = 500\mu\text{A}$	4.923	4.952		V
			$-40^\circ\text{C} \leq T_A \leq +85^\circ\text{C}$	4.916			
			$I_{\text{OUT}} = 1\text{mA}$	4.864	4.904		
			$-40^\circ\text{C} \leq T_A \leq +85^\circ\text{C}$	4.848			
Output Swing Low	$V_{\text{OL}}$	$V_{\text{OUT}}, \overline{V_{\text{OUT}}}$	$I_{\text{OUT}} = -500\mu\text{A}$		52	80	mV
			$-40^\circ\text{C} \leq T_A \leq +85^\circ\text{C}$			90	
			$I_{\text{OUT}} = -1\text{mA}$		104	131	
			$-40^\circ\text{C} \leq T_A \leq +85^\circ\text{C}$			143	
Output Current	$I_{\text{OUT}}$	Source	$V_{\text{OUT}}, \overline{V_{\text{OUT}}}$	14	18		mA
			$-40^\circ\text{C} \leq T_A \leq +85^\circ\text{C}$	12			
		Sink	$V_{\text{OUT}}, \overline{V_{\text{OUT}}}$	15	19		
			$-40^\circ\text{C} \leq T_A \leq +85^\circ\text{C}$	12.9			
Propagation Delay (High to Low)		$V_{\text{OUT}}, \overline{V_{\text{OUT}}}$	Overdrive = 10mV		13		$\mu\text{s}$
			Overdrive = 100mV		6		
Propagation Delay (Low to High)		$V_{\text{OUT}}, \overline{V_{\text{OUT}}}$	Overdrive = 10mV		42		$\mu\text{s}$
			Overdrive = 100mV		33		
Rise Time	$t_{\text{Rise}}$	$V_{\text{OUT}}, \overline{V_{\text{OUT}}}$	Overdrive = 10mV, $C_L = 30\text{pF}$ , $R_L = 1\text{M}\Omega$		85		ns
			Overdrive = 100mV, $C_L = 30\text{pF}$ , $R_L = 1\text{M}\Omega$		85		
Fall Time	$t_{\text{Fall}}$	$V_{\text{OUT}}, \overline{V_{\text{OUT}}}$	Overdrive = 10mV, $C_L = 30\text{pF}$ , $R_L = 1\text{M}\Omega$		70		ns
			Overdrive = 100mV, $C_L = 30\text{pF}$ , $R_L = 1\text{M}\Omega$		60		

SIMPLIFIED SCHEMATIC DIAGRAM

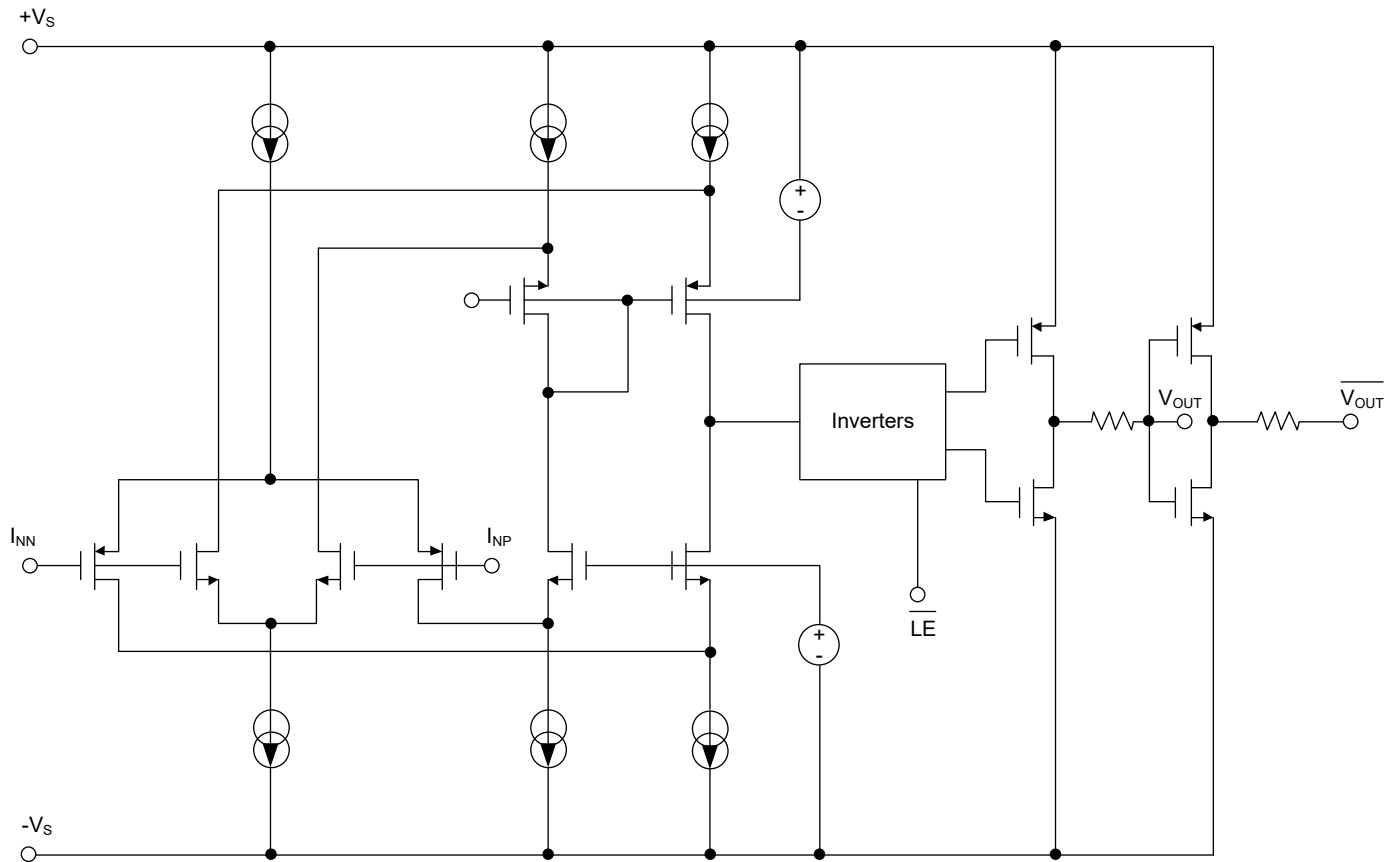

TYPICAL PERFORMANCE CHARACTERISTICS

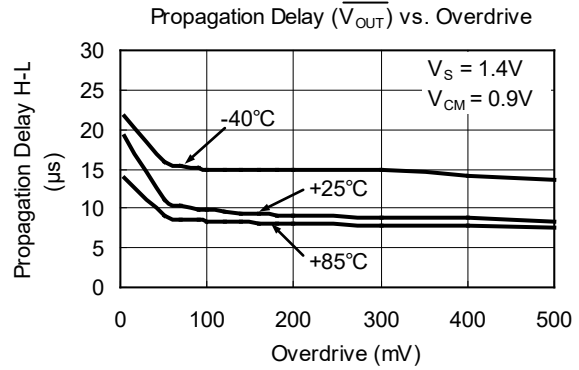
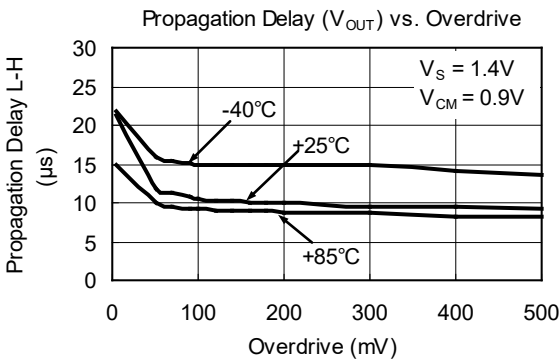
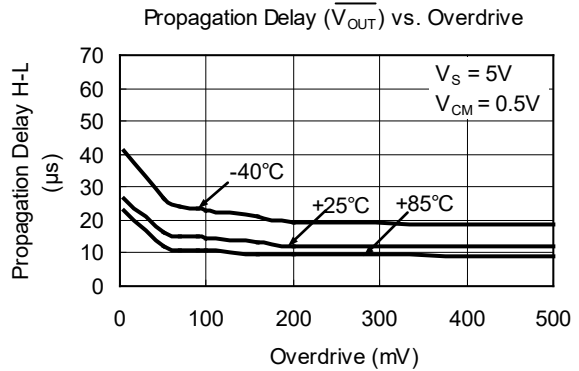
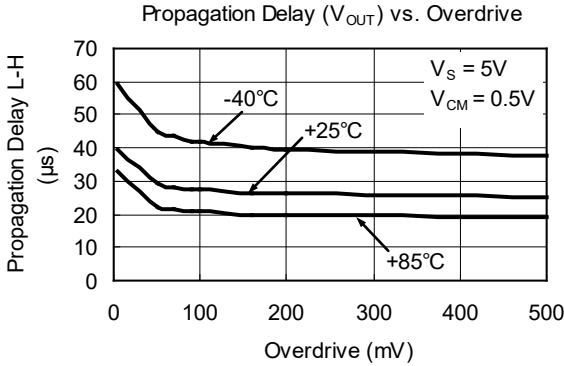
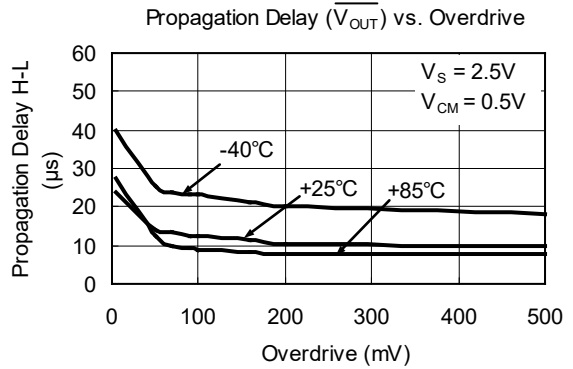
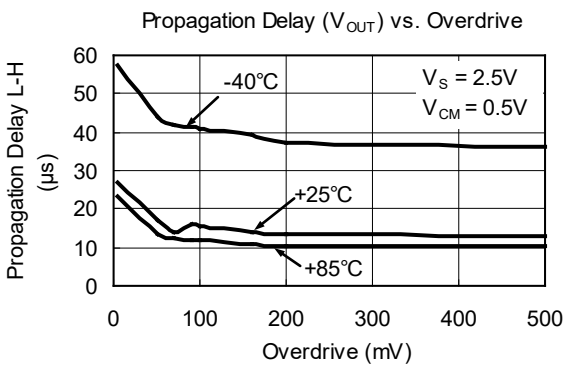
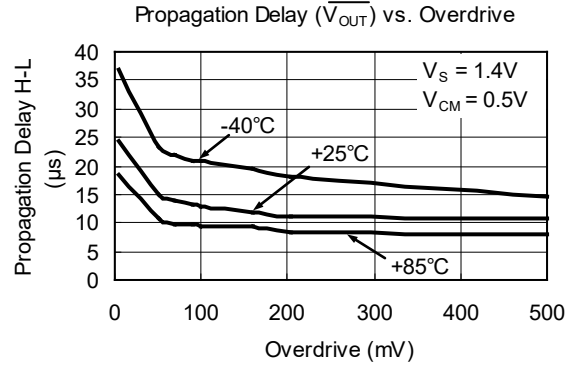
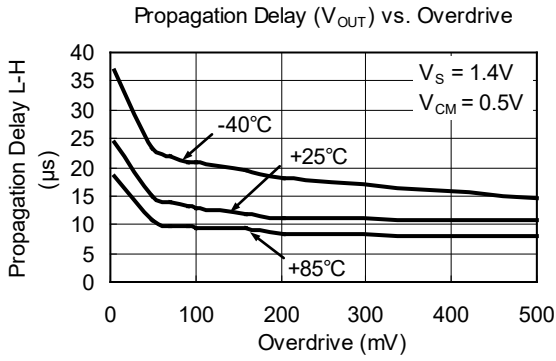

TYPICAL PERFORMANCE CHARACTERISTICS (continued)

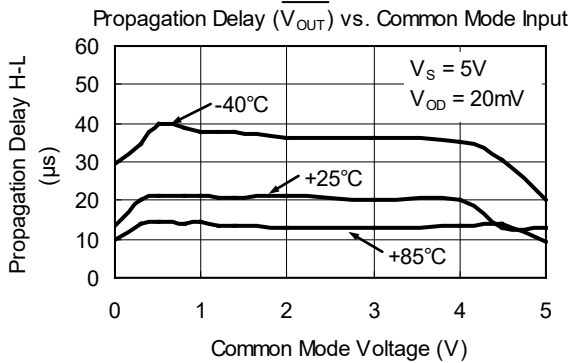
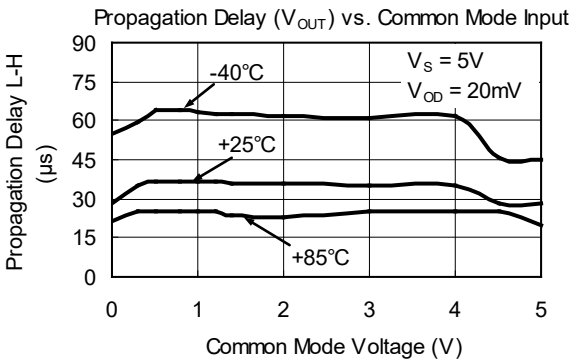
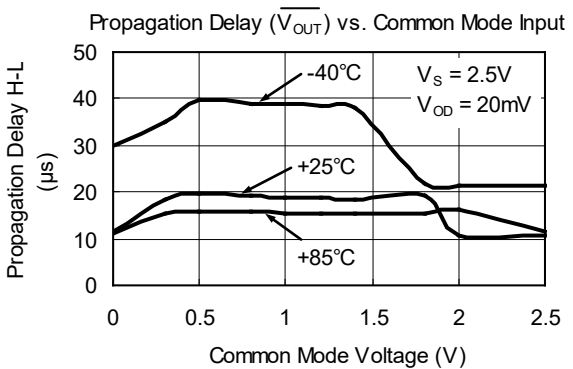
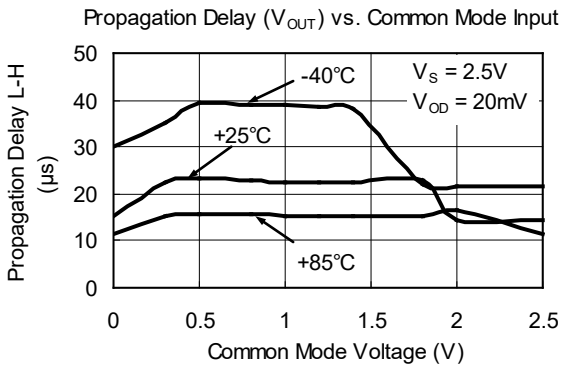
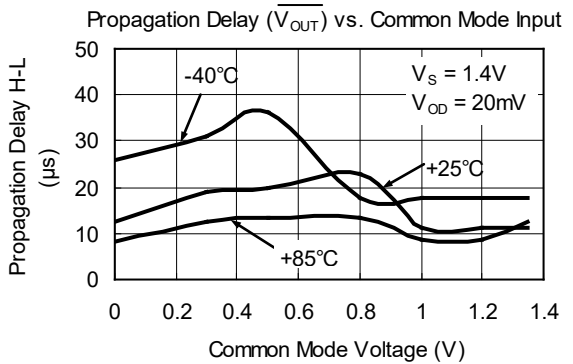
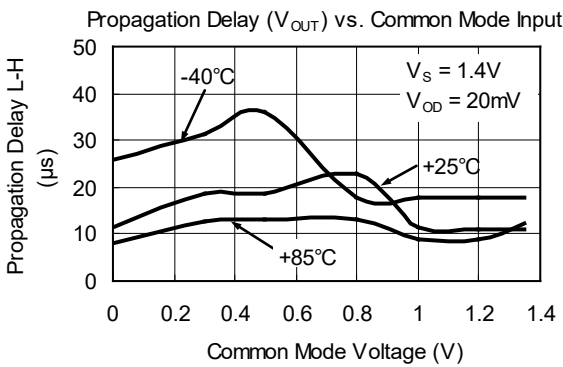
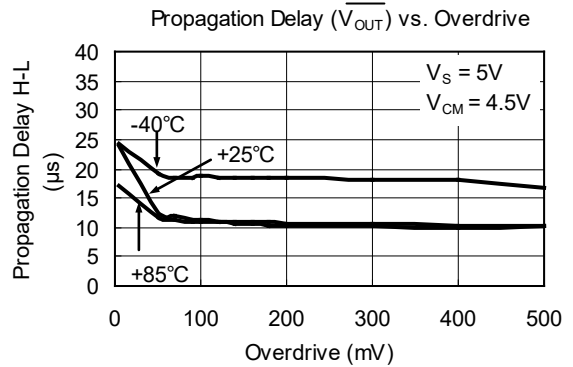
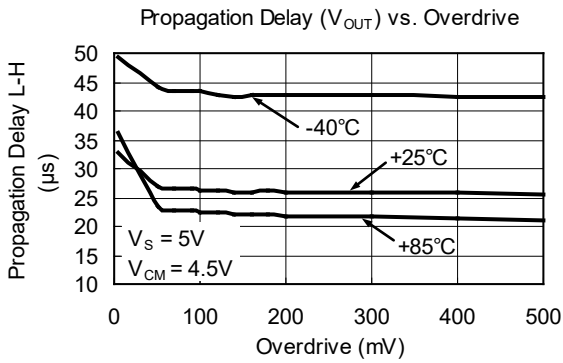



TYPICAL PERFORMANCE CHARACTERISTICS (continued)

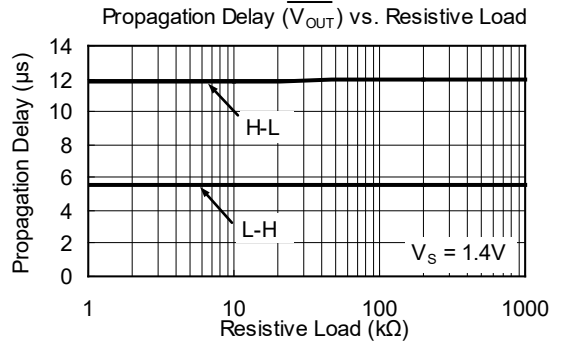
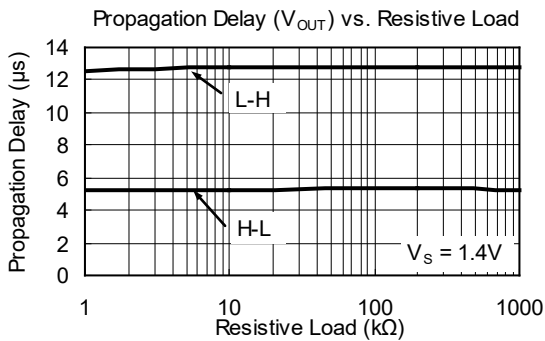
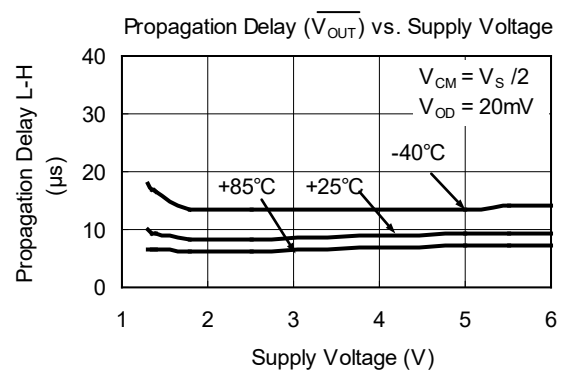
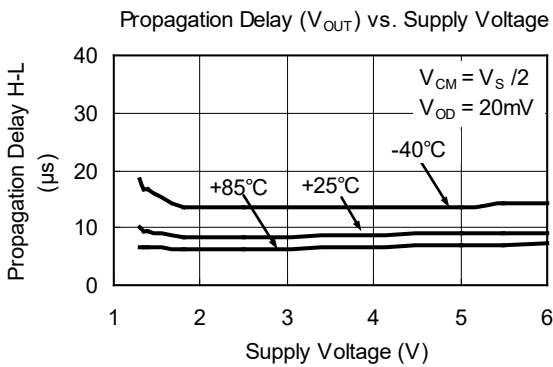
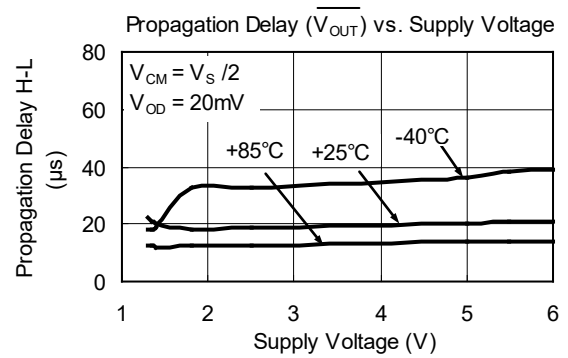
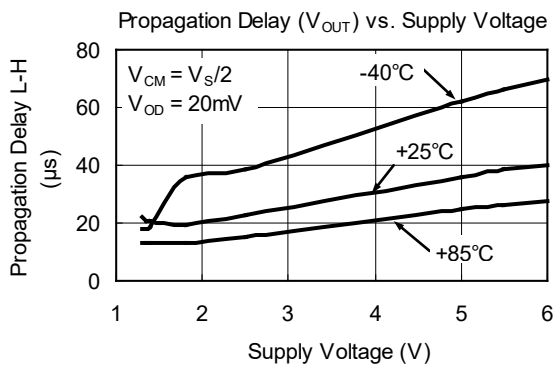
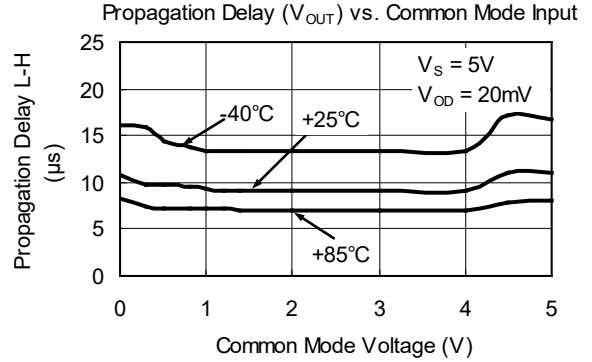
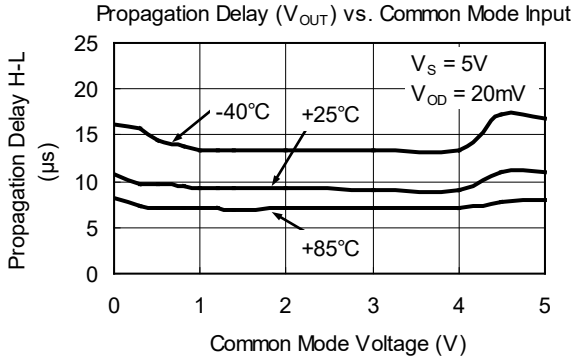

TYPICAL PERFORMANCE CHARACTERISTICS (continued)

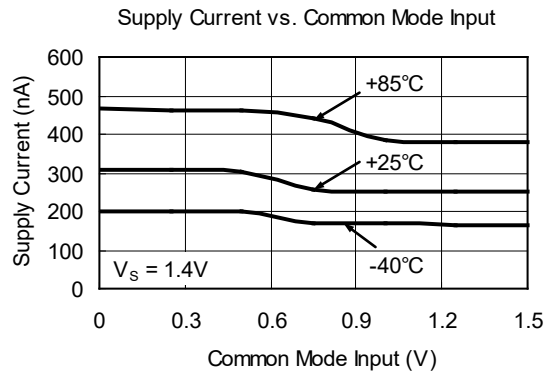
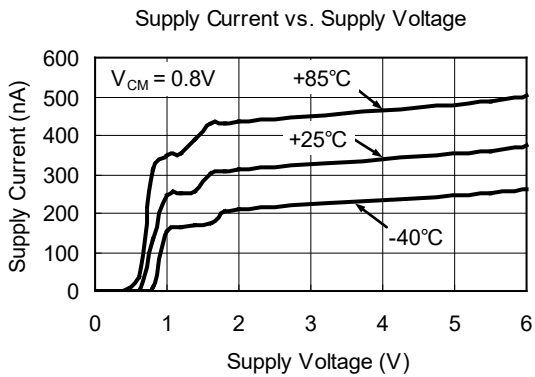
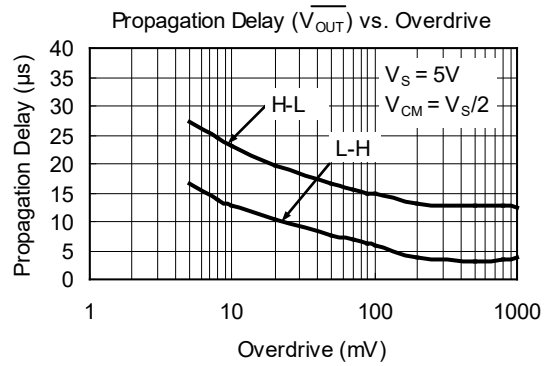
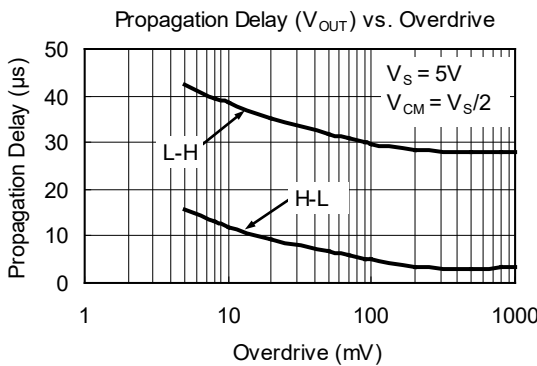
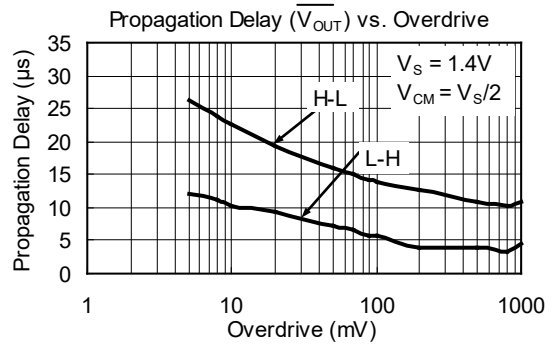
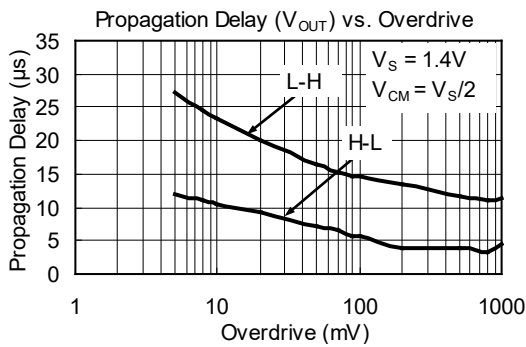
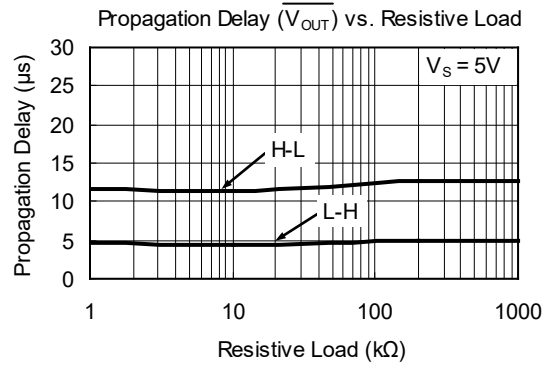
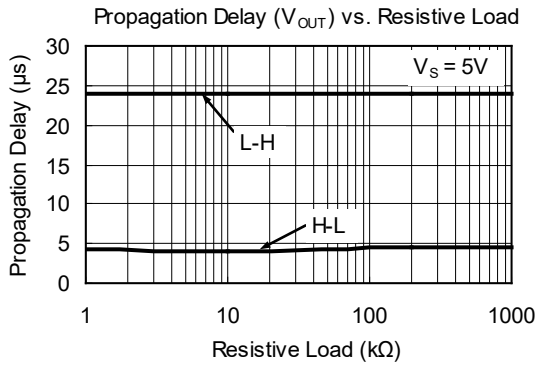

TYPICAL PERFORMANCE CHARACTERISTICS (continued)

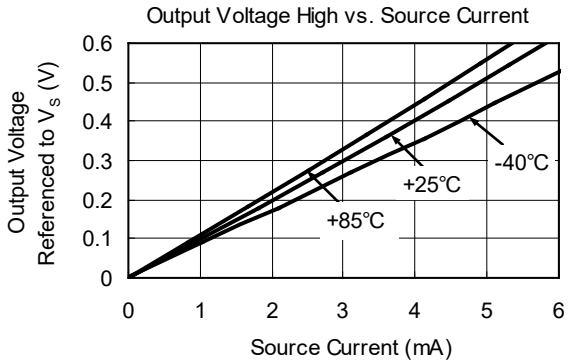
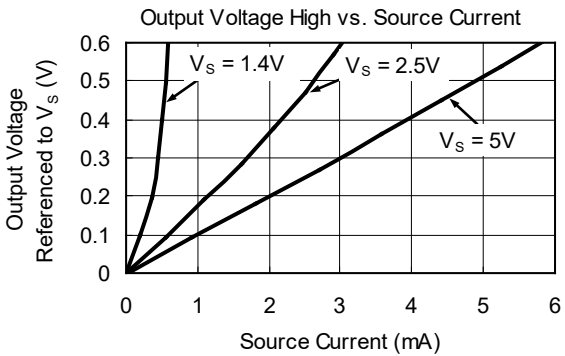
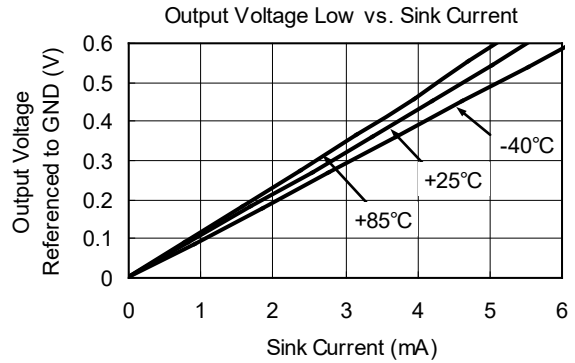
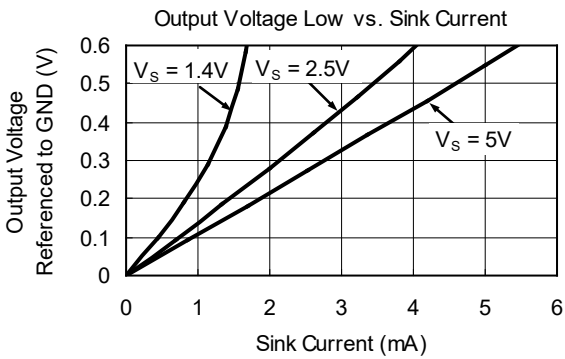
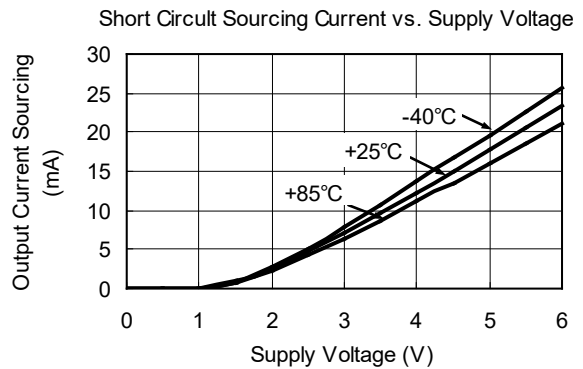
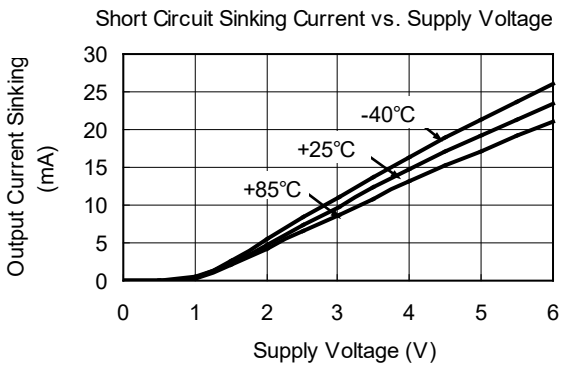
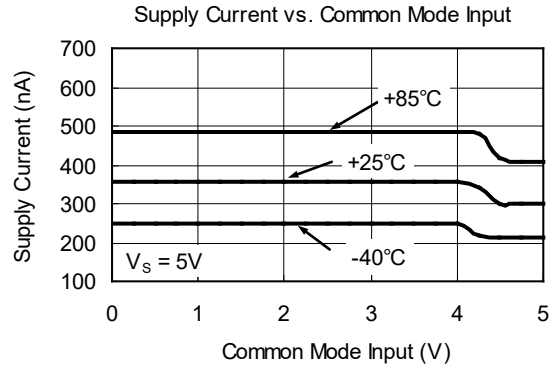
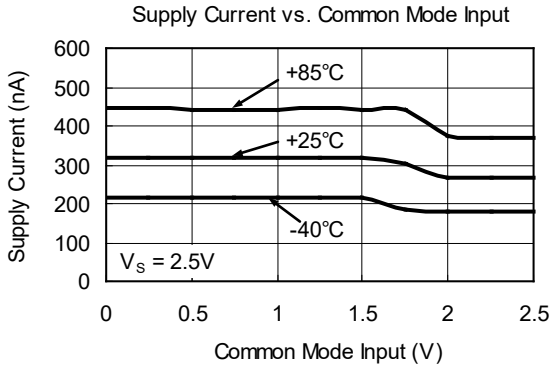

TYPICAL PERFORMANCE CHARACTERISTICS (continued)

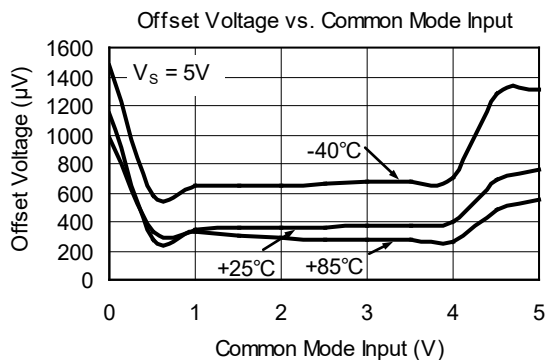

**TIMING DIAGRAM**

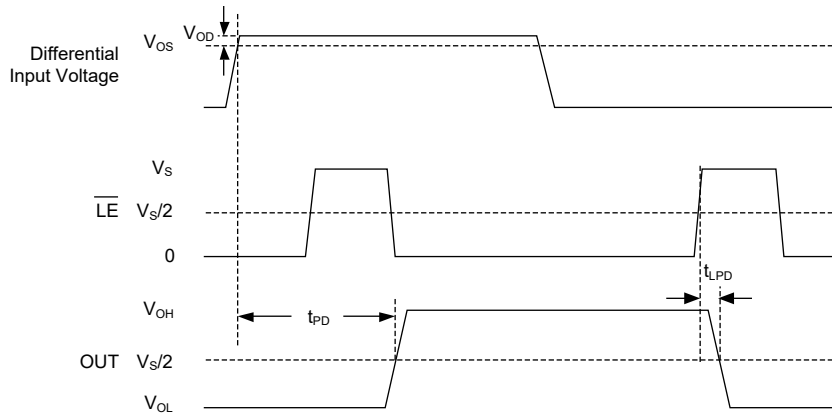

Figure 1. Timing Diagram with Latch Operator

**REVISION HISTORY**

NOTE: Page numbers for previous revisions may differ from page numbers in the current version.

DECEMBER 2013 – REV.A.1 to REV.A.2	Page
Changed Electrical Characteristics section.....	4
Added Electrical Characteristics section.....	5
Added Timing Diagram section .....	13
JUANUARY 2013 – REV.A to REV.A.1	Page
Added Tape and Reel Information section.....	15, 16
Changes from Original (DECEMBER 2011) to REV.A	Page
Changed from product preview to production data.....	All

PACKAGE OUTLINE DIMENSIONS

SOIC-8

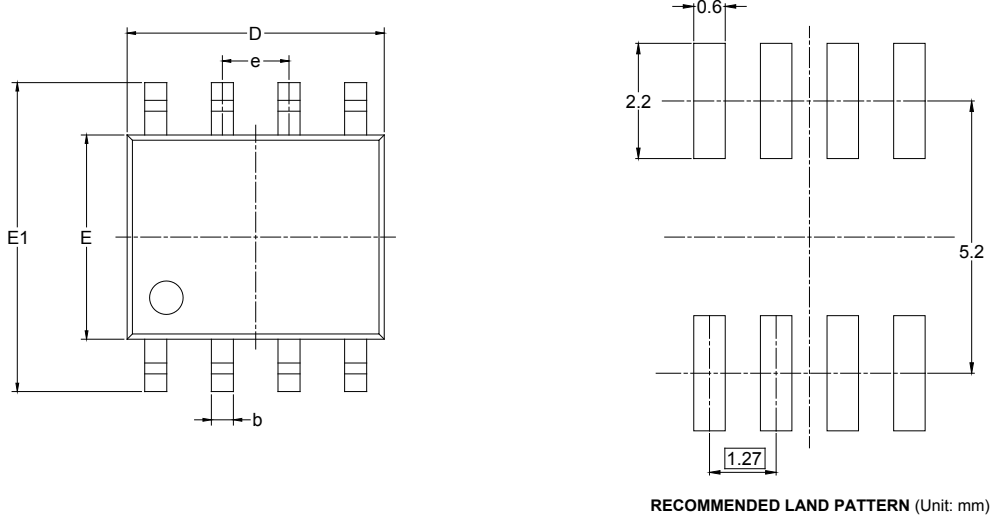

Symbol	Dimensions In Millimeters		Dimensions In Inches	
	MIN	MAX	MIN	MAX
A	1.350	1.750	0.053	0.069
A1	0.100	0.250	0.004	0.010
A2	1.350	1.550	0.053	0.061
b	0.330	0.510	0.013	0.020
c	0.170	0.250	0.006	0.010
D	4.700	5.100	0.185	0.200
E	3.800	4.000	0.150	0.157
E1	5.800	6.200	0.228	0.244
e	1.27 BSC		0.050 BSC	
L	0.400	1.270	0.016	0.050
$\theta$	0°	8°	0°	8°

PACKAGE OUTLINE DIMENSIONS

MSOP-8

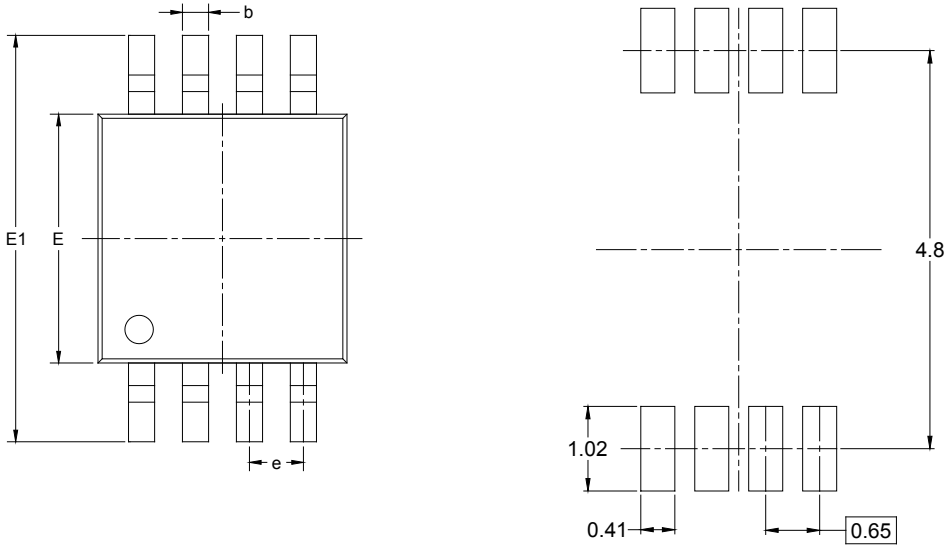

RECOMMENDED LAND PATTERN (Unit: mm)

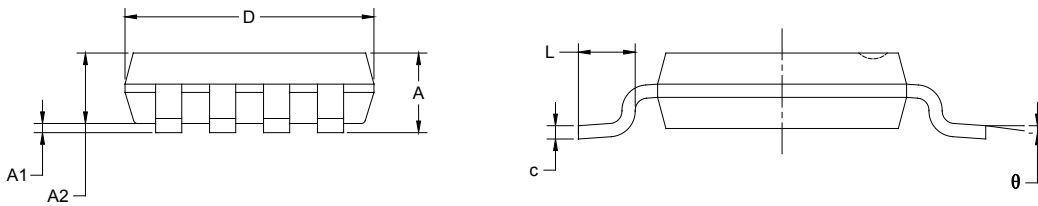

Symbol	Dimensions In Millimeters		Dimensions In Inches	
	MIN	MAX	MIN	MAX
A	0.820	1.100	0.032	0.043
A1	0.020	0.150	0.001	0.006
A2	0.750	0.950	0.030	0.037
b	0.250	0.380	0.010	0.015
c	0.090	0.230	0.004	0.009
D	2.900	3.100	0.114	0.122
E	2.900	3.100	0.114	0.122
E1	4.750	5.050	0.187	0.199
e	0.650 BSC		0.026 BSC	
L	0.400	0.800	0.016	0.031
θ	0°	6°	0°	6°

**TAPE AND REEL INFORMATION**

**REEL DIMENSIONS**



**TAPE DIMENSIONS**



NOTE: The picture is only for reference. Please make the object as the standard.

**KEY PARAMETER LIST OF TAPE AND REEL**

Package Type	Reel Diameter	Reel Width W1 (mm)	A0 (mm)	B0 (mm)	K0 (mm)	P0 (mm)	P1 (mm)	P2 (mm)	W (mm)	Pin1 Quadrant
SOIC-8	13"	12.4	6.40	5.40	2.10	4.0	8.0	2.0	12.0	Q1
MSOP-8	13"	12.4	5.20	3.30	1.50	4.0	8.0	2.0	12.0	Q1

DD0001



# PACKAGE INFORMATION

## CARTON BOX DIMENSIONS



NOTE: The picture is only for reference. Please make the object as the standard.

## KEY PARAMETER LIST OF CARTON BOX

Reel Type	Length (mm)	Width (mm)	Height (mm)	Pizza/Carton
13"	386	280	370	5

DD0002