



# SGM8422/SGM8424 2.4MHz, High Voltage, Rail-to-Rail I/O Operational Amplifiers

## GENERAL DESCRIPTION

The SGM8422 (dual) and SGM8424 (quad) are low power, high voltage, rail-to-rail input and output operational amplifiers. These devices can operate from  $\pm 2.25\text{V}$  to  $\pm 15\text{V}$  dual power supplies or from 4.5V to 30V single supply.

The SGM8422/4 have a gain-bandwidth product of 2.4MHz (TYP), while consuming only 0.72mA per amplifier. They also provide common mode input ability beyond the supply rails, as well as rail-to-rail output capability. This enables the SGM8422/4 to offer maximum dynamic range at any supply voltage.

The SGM8422/4 also feature fast slewing and settling times. These features make these amplifiers ideal for use as voltage reference buffers in Thin Film Transistor Liquid Crystal Displays (TFT-LCD). Other applications include battery power, portable devices, and anywhere low power consumption is important.

The SGM8422 comes in Green SOIC-8 and MSOP-8 packages. The SGM8424 is offered in Green TSSOP-14 and SOIC-14 packages. They are specified over the extended  $-40^{\circ}\text{C}$  to  $+85^{\circ}\text{C}$  temperature range.

## FEATURES

- $\pm 2.25\text{V}$  to  $\pm 15\text{V}$  Dual Power Supplies or 4.5V to 30V Single Supply
- Gain-Bandwidth Product: 2.4MHz (TYP)
- Supply Current: 0.72mA/Amplifier
- High Slew Rate: 2V/ $\mu\text{s}$
- Beyond the Rails Input Capability
- Rail-to-Rail Output Swing
- $-40^{\circ}\text{C}$  to  $+85^{\circ}\text{C}$  Operating Temperature Range
- Small Packaging:  
SGM8422 Available in SOIC-8 and MSOP-8 Packages  
SGM8424 Available in TSSOP-14 and SOIC-14 Packages

## APPLICATIONS

TFT-LCD Drive Circuits  
Electronics Notebooks  
Electronics Games  
Touch-Screen Displays  
Wireless LANs  
Office Automation  
Personal Communication Devices  
Personal Digital Assistants (PDAs)  
Portable Instrumentation  
A/D Converter Buffers  
Active Filters

**PACKAGE/ORDERING INFORMATION**

MODEL	PACKAGE DESCRIPTION	SPECIFIED TEMPERATURE RANGE	ORDERING NUMBER	PACKAGE MARKING	PACKING OPTION
SGM8422	SOIC-8	-40°C to +85°C	SGM8422YS8G/TR	SGM 8422YS8 XXXXX	Tape and Reel, 2500
	MSOP-8	-40°C to +85°C	SGM8422YMS8G/TR	SGM8422 YMS8 XXXXX	Tape and Reel, 3000
SGM8424	SOIC-14	-40°C to +85°C	SGM8424YS14G/TR	SGM8424YS14 XXXXX	Tape and Reel, 2500
	TSSOP-14	-40°C to +85°C	SGM8424YTS14G/TR	SGM8424 YTS14 XXXXX	Tape and Reel, 3000

**MARKING INFORMATION**

NOTE: XXXXX = Date Code and Vendor Code.

**SOIC-8/MSOP-8/SOIC-14/TSSOP-14**

**XXXXX**

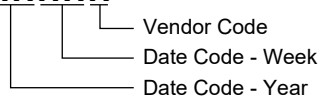

Green (RoHS & HSF): SG Micro Corp defines "Green" to mean Pb-Free (RoHS compatible) and free of halogen substances. If you have additional comments or questions, please contact your SGMICRO representative directly.

**ABSOLUTE MAXIMUM RATINGS**

- Supply Voltage, +V<sub>S</sub> to -V<sub>S</sub> ..... 32V
- Input Common Mode Voltage Range  
..... (-V<sub>S</sub>) - 0.1V to (+V<sub>S</sub>) + 0.1V
- Input/Output Voltage Range ..... (-V<sub>S</sub>) - 0.3V to (+V<sub>S</sub>) + 0.3V
- Junction Temperature ..... +150°C
- Storage Temperature Range ..... -65°C to +150°C
- Lead Temperature (Soldering, 10s) ..... +260°C
- ESD Susceptibility
- HBM (SGM8422) ..... 3000V
- HBM (SGM8424) ..... 4000V
- MM (SGM8422) ..... 150V
- MM (SGM8424) ..... 250V

**RECOMMENDED OPERATING CONDITIONS**

- Operating Temperature Range ..... -40°C to +85°C

**OVERSTRESS CAUTION**

Stresses beyond those listed in Absolute Maximum Ratings may cause permanent damage to the device. Exposure to absolute maximum rating conditions for extended periods may affect reliability. Functional operation of the device at any conditions beyond those indicated in the Recommended Operating Conditions section is not implied.

**ESD SENSITIVITY CAUTION**

This integrated circuit can be damaged by ESD if you don't pay attention to ESD protection. SGMICRO recommends that all integrated circuits be handled with appropriate precautions. Failure to observe proper handling and installation procedures can cause damage. ESD damage can range from subtle performance degradation to complete device failure. Precision integrated circuits may be more susceptible to damage because very small parametric changes could cause the device not to meet its published specifications.

**DISCLAIMER**

SG Micro Corp reserves the right to make any change in circuit design, or specifications without prior notice.

**PIN CONFIGURATIONS**

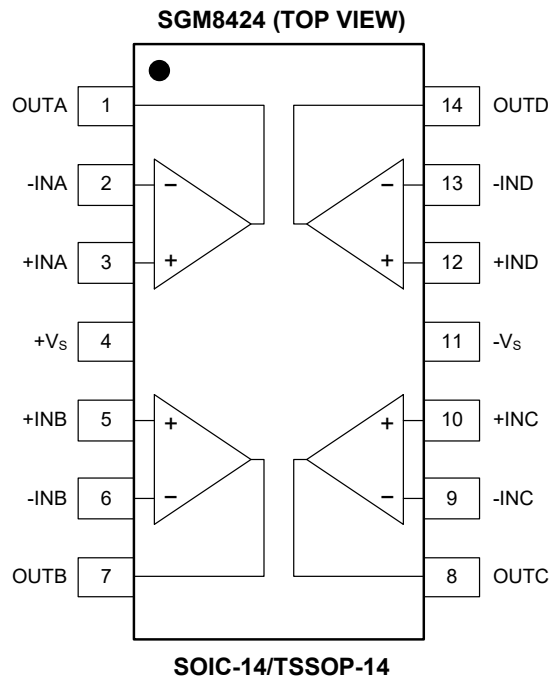
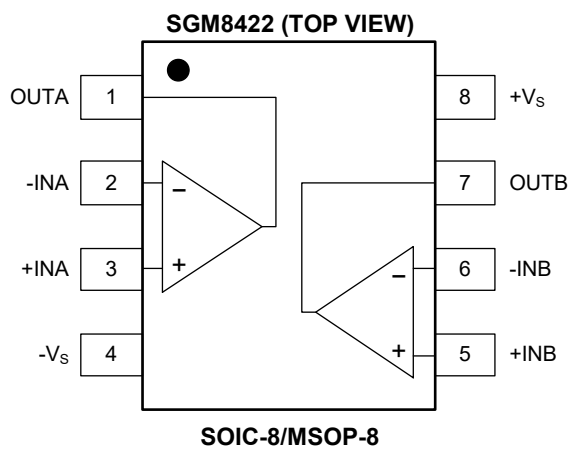

**ELECTRICAL CHARACTERISTICS**

(At  $T_A = +25^\circ\text{C}$ ,  $V_S = 5\text{V}$ ,  $R_L = 2\text{k}\Omega$  connected to  $V_S/2$ , Full =  $-40^\circ\text{C}$  to  $+85^\circ\text{C}$ , unless otherwise noted.)

PARAMETER	CONDITIONS	TEMP	MIN	TYP	MAX	UNITS	
<b>Input Characteristics</b>							
Input Offset Voltage ( $V_{OS}$ )	$V_{CM} = V_S/2$	+25°C		1.5	5.8	mV	
		Full			6.1		
Input Offset Current ( $I_{OS}$ )		+25°C		10		pA	
Input Bias Current ( $I_B$ )		+25°C		10		pA	
Common Mode Rejection Ratio (CMRR)	$V_{CM} = -0.1\text{V}$ to $5.1\text{V}$	+25°C	54	65		dB	
		Full	51				
Open-Loop Voltage Gain ( $A_{OL}$ )	$V_{OUT} = 0.5\text{V}$ to $4.5\text{V}$	+25°C	80	105		dB	
		Full	77				
<b>Output Characteristics</b>							
Output Voltage Swing from Rail	$V_{OH}$	$I_{OUT} = 70\text{mA}$	+25°C		1.12	1.46	V
			Full			1.79	
		$R_L = 2\text{k}\Omega$	+25°C		21	38	mV
	Full				43		
	+25°C			1.09	1.43	V	
	$V_{OL}$	$I_{OUT} = -70\text{mA}$	Full				1.87
+25°C				21	36	mV	
Full				43			
Output Short-Circuit Current ( $I_{SC}$ )	Sink	$R_L = 10\Omega$ to $V_S/2$	+25°C		73.4	mA	
	Source	$R_L = 10\Omega$ to $V_S/2$	+25°C		67.8		
<b>Power Supply</b>							
Power Supply Rejection Ratio (PSRR)	$V_S = 4.5\text{V}$ to $30\text{V}$ , $V_{CM} = V_S/2$	+25°C	85	102		dB	
		Full	82				
Quiescent Current/Amplifier ( $I_Q$ )	$I_{OUT} = 0\text{A}$	+25°C		0.66	0.90	mA	
		Full			1.07		
<b>Dynamic Performance</b>							
Gain-Bandwidth Product (GBP)	$R_L = 2\text{k}\Omega$ , $C_L = 100\text{pF}$ , $V_{CM} = V_S/2$	+25°C		2.3		MHz	
Slew Rate (SR)	$V_{OUT} = 2V_{PP}$ step, $A_V = 1$	+25°C		2		V/ $\mu\text{s}$	
Gain Margin	$R_L = 2\text{k}\Omega$ , $C_L = 100\text{pF}$ , $V_{CM} = V_S/2$	+25°C		-8.9		dB	
Phase Margin	$R_L = 2\text{k}\Omega$ , $C_L = 100\text{pF}$ , $V_{CM} = V_S/2$	+25°C		49		°	
Crosstalk	$f = 1\text{MHz}$	+25°C		-74		dB	
<b>Noise Performance</b>							
Input Voltage Noise Density ( $e_n$ )	$f = 1\text{kHz}$ , $V_{CM} = V_S/2$	+25°C		80		nV/ $\sqrt{\text{Hz}}$	
	$f = 10\text{kHz}$ , $V_{CM} = V_S/2$	+25°C		40			

**ELECTRICAL CHARACTERISTICS (continued)**

(At  $T_A = +25^\circ\text{C}$ ,  $V_S = 15\text{V}$ ,  $R_L = 2\text{k}\Omega$  connected to  $V_S/2$ , Full =  $-40^\circ\text{C}$  to  $+85^\circ\text{C}$ , unless otherwise noted.)

PARAMETER	CONDITIONS	TEMP	MIN	TYP	MAX	UNITS	
<b>Input Characteristics</b>							
Input Offset Voltage ( $V_{OS}$ )	$V_{CM} = V_S/2$	+25°C		1.5	6.3	mV	
		Full			6.6		
Input Offset Current ( $I_{OS}$ )		+25°C		10		pA	
Input Bias Current ( $I_B$ )		+25°C		10		pA	
Common Mode Rejection Ratio (CMRR)	$V_{CM} = -0.1\text{V}$ to $15.1\text{V}$	+25°C	61	73		dB	
		Full	58				
Open-Loop Voltage Gain ( $A_{OL}$ )	$V_{OUT} = 0.5\text{V}$ to $14.5\text{V}$	+25°C	91	113		dB	
		Full	88				
<b>Output Characteristics</b>							
Output Voltage Swing from Rail	$V_{OH}$	$R_L = 2\text{k}\Omega$	+25°C		56	101	mV
			Full			114	
	$V_{OL}$	$R_L = 2\text{k}\Omega$	+25°C		59	90	
			Full			104	
Output Current ( $I_{OUT}$ )		+25°C		80		mA	
<b>Power Supply</b>							
Quiescent Current/Amplifier ( $I_Q$ )	$I_{OUT} = 0\text{A}$	+25°C		0.68	0.93	mA	
		Full			1.10		
<b>Dynamic Performance</b>							
Gain-Bandwidth Product (GBP)	$R_L = 2\text{k}\Omega$ , $C_L = 100\text{pF}$ , $V_{CM} = V_S/2$	+25°C		2.4		MHz	
Slew Rate (SR)	$V_{OUT} = 2V_{PP}$ step, $A_V = 1$	+25°C		2		V/ $\mu\text{s}$	
Gain Margin	$R_L = 2\text{k}\Omega$ , $C_L = 100\text{pF}$ , $V_{CM} = V_S/2$	+25°C		-6.7		dB	
Phase Margin	$R_L = 2\text{k}\Omega$ , $C_L = 100\text{pF}$ , $V_{CM} = V_S/2$	+25°C		46		°	
Crosstalk	$f = 1\text{MHz}$	+25°C		-73		dB	
<b>Noise Performance</b>							
Input Voltage Noise Density ( $e_n$ )	$f = 1\text{kHz}$ , $V_{CM} = V_S/2$	+25°C		73		nV/ $\sqrt{\text{Hz}}$	
	$f = 10\text{kHz}$ , $V_{CM} = V_S/2$	+25°C		40			

**ELECTRICAL CHARACTERISTICS (continued)**

(At  $T_A = +25^\circ\text{C}$ ,  $V_S = \pm 15\text{V}$ ,  $R_L = 2\text{k}\Omega$  connected to 0V, Full =  $-40^\circ\text{C}$  to  $+85^\circ\text{C}$ , unless otherwise noted.)

PARAMETER		CONDITIONS	TEMP	MIN	TYP	MAX	UNITS
<b>Input Characteristics</b>							
Input Offset Voltage ( $V_{OS}$ )		$V_{CM} = 0\text{V}$	+25°C		1.5	6	mV
			Full			6.3	
Input Offset Current ( $I_{OS}$ )			+25°C		10		pA
Input Bias Current ( $I_B$ )			+25°C		10		pA
Common Mode Rejection Ratio (CMRR)		$V_{CM} = -15.1\text{V}$ to $15.1\text{V}$	+25°C	69	81		dB
			Full	66			
Open-Loop Voltage Gain ( $A_{OL}$ )		$V_{OUT} = -14.5\text{V}$ to $14.5\text{V}$	+25°C	94	115		dB
			Full	91			
<b>Output Characteristics</b>							
Output Voltage Swing from Rail	$V_{OH}$	$R_L = 2\text{k}\Omega$	+25°C		129	195	mV
			Full			225	
	$V_{OL}$	$R_L = 2\text{k}\Omega$	+25°C		125	180	
			Full			215	
Output Current ( $I_{OUT}$ )			+25°C		80		mA
<b>Power Supply</b>							
Quiescent Current/Amplifier ( $I_Q$ )		$I_{OUT} = 0\text{A}$	+25°C		0.72	0.96	mA
			Full			1.14	
<b>Dynamic Performance</b>							
Gain-Bandwidth Product (GBP)		$R_L = 2\text{k}\Omega$ , $C_L = 100\text{pF}$ , $V_{CM} = 0\text{V}$	+25°C		2.4		MHz
Slew Rate (SR)		$V_{OUT} = 2V_{PP}$ step, $A_V = 1$	+25°C		2		V/ $\mu\text{s}$
Gain Margin		$R_L = 2\text{k}\Omega$ , $C_L = 100\text{pF}$ , $V_{CM} = 0\text{V}$	+25°C		-8.6		dB
Phase Margin		$R_L = 2\text{k}\Omega$ , $C_L = 100\text{pF}$ , $V_{CM} = 0\text{V}$	+25°C		48		°
Crosstalk		$f = 1\text{MHz}$	+25°C		-73		dB
<b>Noise Performance</b>							
Input Voltage Noise Density ( $e_n$ )		$f = 1\text{kHz}$ , $V_{CM} = 0\text{V}$	+25°C		74		nV/ $\sqrt{\text{Hz}}$
			+25°C		46		

**TYPICAL PERFORMANCE CHARACTERISTICS**

At  $T_A = +25^\circ\text{C}$ ,  $V_S = \pm 15\text{V}$ ,  $R_L = 2\text{k}\Omega$  connected to  $0\text{V}$ , unless otherwise noted.

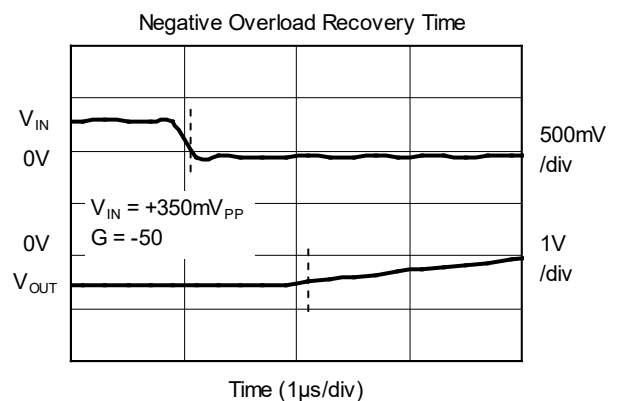
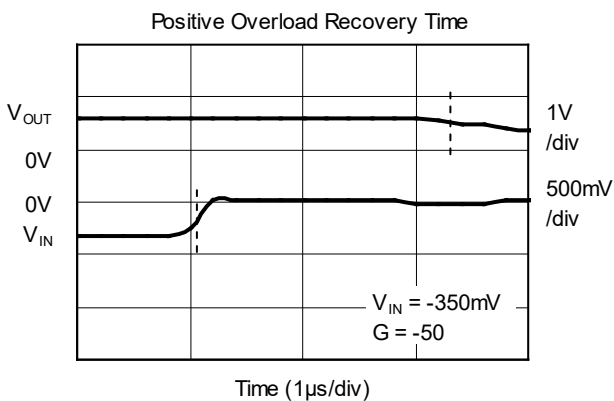
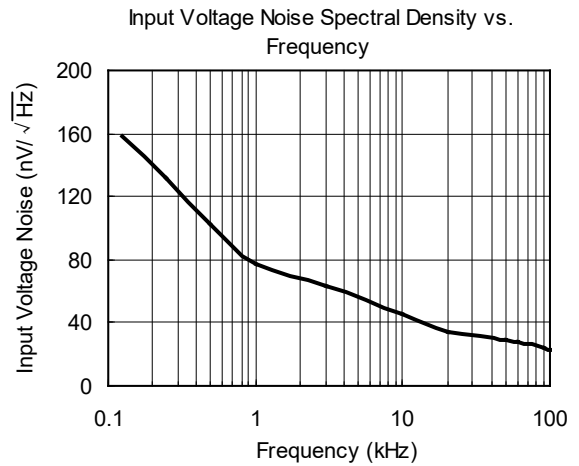
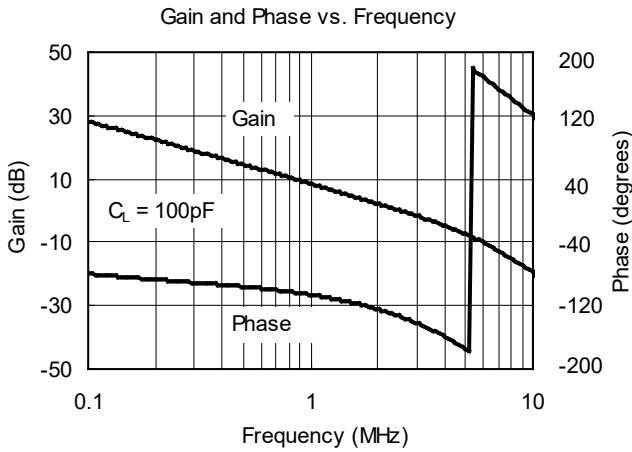
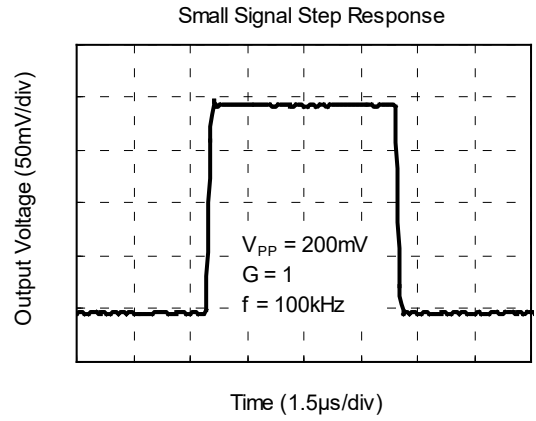
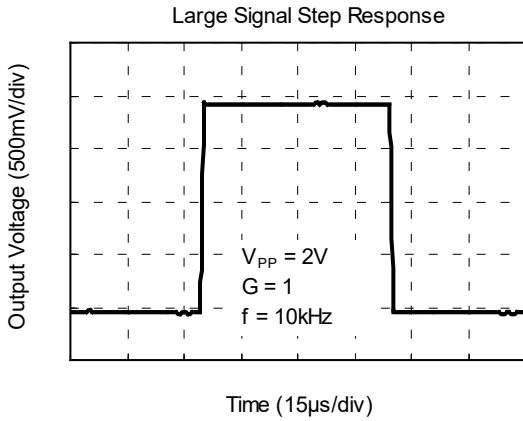

## **REVISION HISTORY**

NOTE: Page numbers for previous revisions may differ from page numbers in the current version.

<b>OCTOBER 2013 – REV.A.1 to REV.A.2</b>	<b>Page</b>
Changed Electrical Characteristics section .....	5, 6

---

<b>APRIL 2013 – REV.A to REV.A.1</b>	<b>Page</b>
Updated Electrical Characteristics section .....	4 ~ 6

---

<b>Changes from Original (SEPTEMBER 2012) to REV.A</b>	<b>Page</b>
Changed from product preview to production data .....	All

---



PACKAGE OUTLINE DIMENSIONS

SOIC-8

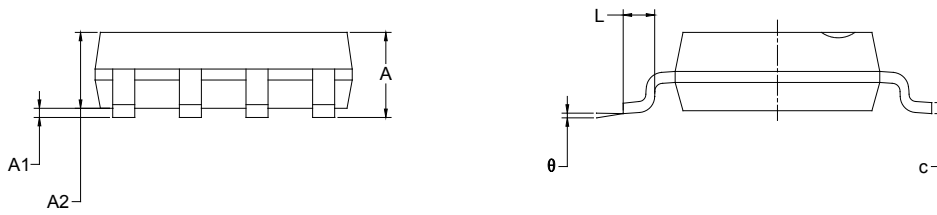
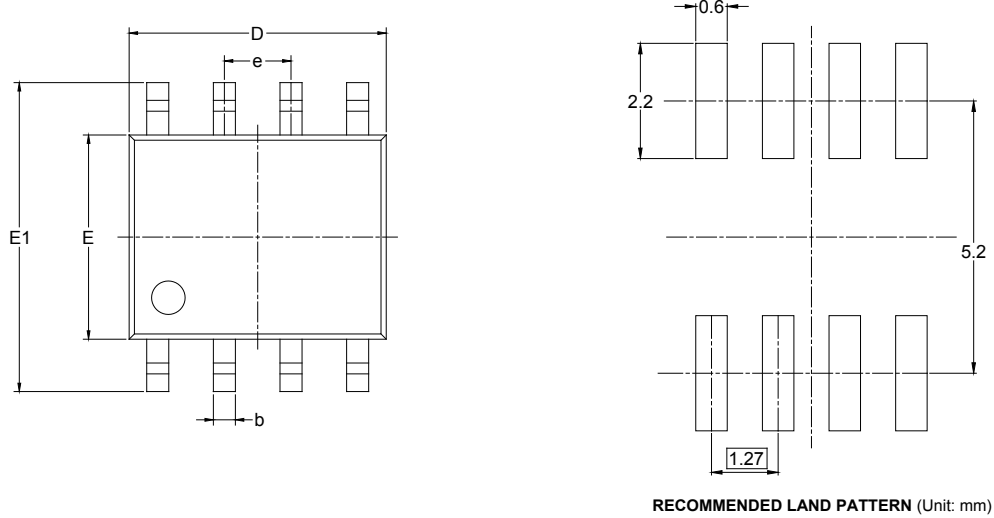

Symbol	Dimensions In Millimeters		Dimensions In Inches	
	MIN	MAX	MIN	MAX
A	1.350	1.750	0.053	0.069
A1	0.100	0.250	0.004	0.010
A2	1.350	1.550	0.053	0.061
b	0.330	0.510	0.013	0.020
c	0.170	0.250	0.006	0.010
D	4.700	5.100	0.185	0.200
E	3.800	4.000	0.150	0.157
E1	5.800	6.200	0.228	0.244
e	1.27 BSC		0.050 BSC	
L	0.400	1.270	0.016	0.050
θ	0°	8°	0°	8°

PACKAGE OUTLINE DIMENSIONS

MSOP-8

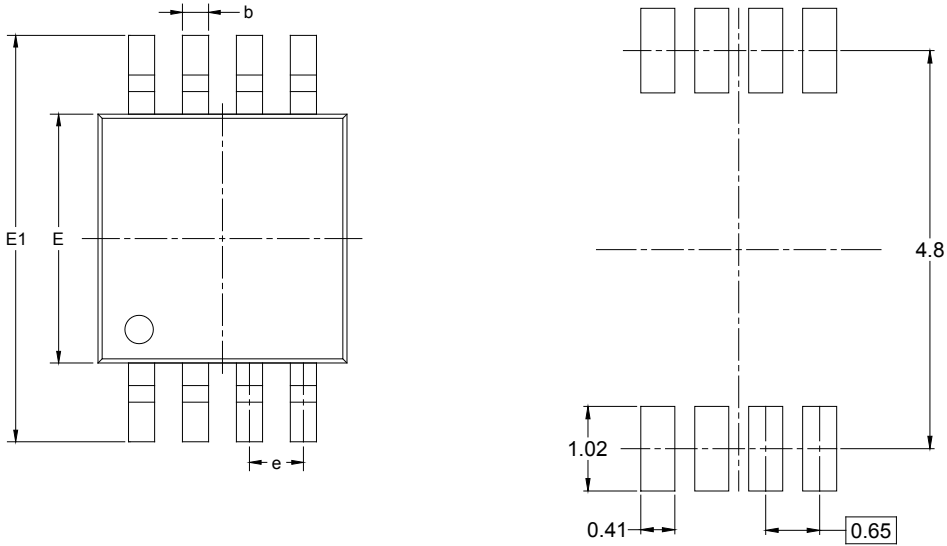

RECOMMENDED LAND PATTERN (Unit: mm)

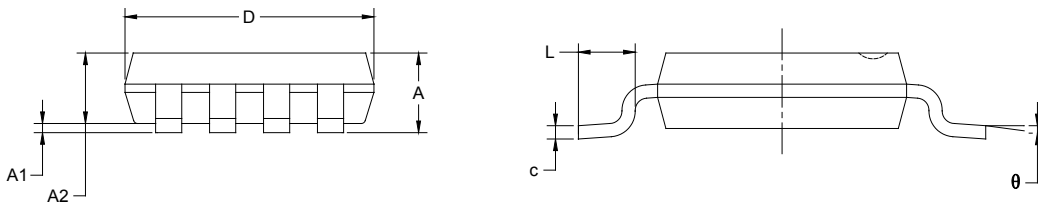

Symbol	Dimensions In Millimeters		Dimensions In Inches	
	MIN	MAX	MIN	MAX
A	0.820	1.100	0.032	0.043
A1	0.020	0.150	0.001	0.006
A2	0.750	0.950	0.030	0.037
b	0.250	0.380	0.010	0.015
c	0.090	0.230	0.004	0.009
D	2.900	3.100	0.114	0.122
E	2.900	3.100	0.114	0.122
E1	4.750	5.050	0.187	0.199
e	0.650 BSC		0.026 BSC	
L	0.400	0.800	0.016	0.031
θ	0°	6°	0°	6°

# PACKAGE INFORMATION

## PACKAGE OUTLINE DIMENSIONS

### SOIC-14

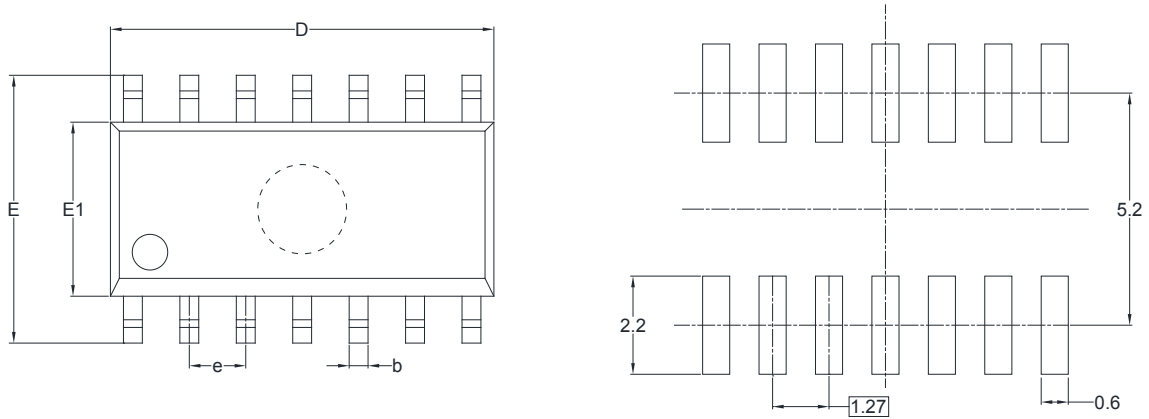

RECOMMENDED LAND PATTERN (Unit: mm)

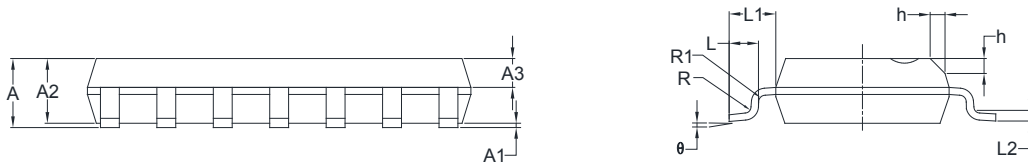

Symbol	Dimensions In Millimeters		Dimensions In Inches	
	MIN	MAX	MIN	MAX
A	1.35	1.75	0.053	0.069
A1	0.10	0.25	0.004	0.010
A2	1.25	1.65	0.049	0.065
A3	0.55	0.75	0.022	0.030
b	0.36	0.49	0.014	0.019
D	8.53	8.73	0.336	0.344
E	5.80	6.20	0.228	0.244
E1	3.80	4.00	0.150	0.157
e	1.27 BSC		0.050 BSC	
L	0.45	0.80	0.018	0.032
L1	1.04 REF		0.040 REF	
L2	0.25 BSC		0.01 BSC	
R	0.07		0.003	
R1	0.07		0.003	
h	0.30	0.50	0.012	0.020
θ	0°	8°	0°	8°

PACKAGE OUTLINE DIMENSIONS

TSSOP-14

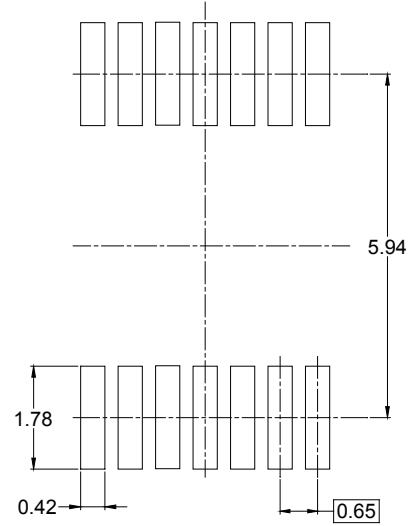
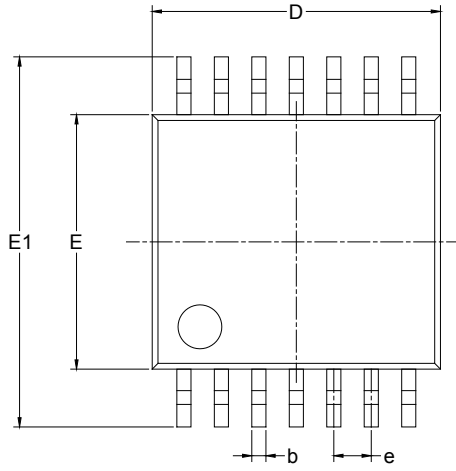

RECOMMENDED LAND PATTERN (Unit: mm)

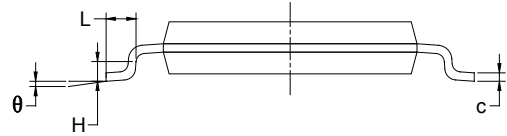
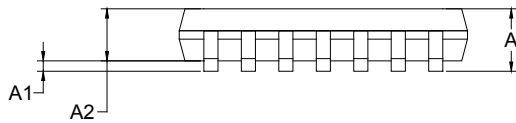

Symbol	Dimensions In Millimeters		Dimensions In Inches	
	MIN	MAX	MIN	MAX
A		1.200		0.047
A1	0.050	0.150	0.002	0.006
A2	0.800	1.050	0.031	0.041
b	0.190	0.300	0.007	0.012
c	0.090	0.200	0.004	0.008
D	4.860	5.100	0.191	0.201
E	4.300	4.500	0.169	0.177
E1	6.250	6.550	0.246	0.258
e	0.650 BSC		0.026 BSC	
L	0.500	0.700	0.02	0.028
H	0.25 TYP		0.01 TYP	
θ	1°	7°	1°	7°

# PACKAGE INFORMATION

## TAPE AND REEL INFORMATION

### REEL DIMENSIONS



### TAPE DIMENSIONS



NOTE: The picture is only for reference. Please make the object as the standard.

### KEY PARAMETER LIST OF TAPE AND REEL

Package Type	Reel Diameter	Reel Width W1 (mm)	A0 (mm)	B0 (mm)	K0 (mm)	P0 (mm)	P1 (mm)	P2 (mm)	W (mm)	Pin1 Quadrant
SOIC-8	13"	12.4	6.40	5.40	2.10	4.0	8.0	2.0	12.0	Q1
MSOP-8	13"	12.4	5.20	3.30	1.50	4.0	8.0	2.0	12.0	Q1
SOIC-14	13"	16.4	6.60	9.30	2.10	4.0	8.0	2.0	16.0	Q1
TSSOP-14	13"	12.4	6.95	5.60	1.20	4.0	8.0	2.0	12.0	Q1

DD0001

# PACKAGE INFORMATION

## CARTON BOX DIMENSIONS



NOTE: The picture is only for reference. Please make the object as the standard.

## KEY PARAMETER LIST OF CARTON BOX

Reel Type	Length (mm)	Width (mm)	Height (mm)	Pizza/Carton
13"	386	280	370	5

DD0002