



SGM4918

80mW, Capless, Stereo Headphone Amplifier with Shutdown

GENERAL DESCRIPTION

The SGM4918 stereo headphone amplifier is designed for portable equipment where board space is at a premium. The SGM4918 uses capless architecture to produce a ground-referenced output from a single power supply, eliminating the need for large DC-blocking capacitors for output, saving cost, board space, and component height. Additionally, for SGM4918B, the gain is set internally (-2V/V), further reducing component count. For SGM4918A, the gain can be adjusted by external feedback resistors.

The SGM4918 delivers up to 80mW per channel into a 32Ω load and has low 0.03% THD+N. A -78dB power supply rejection ratio (PSRR) at 217Hz allows this device to operate from noisy digital supplies without an additional linear regulator. Comprehensive click-and-pop circuitry suppresses audible clicks and pops on startup and shutdown.

The SGM4918 operates from a single 2.7V to 5.1V supply, consumes only 5.8mA supply current, has short-circuit and thermal-overload protections, and is specified over the extended -40°C to +85°C temperature range. The SGM4918 is available in a Green TDFN-3×3-10L package.

FEATURES

- **SGM4918A: External Feedback Gain Network**
SGM4918B: Fixed -2V/V Gain
- **No Bulky DC-Blocking Capacitors Required**
- **Ground-Referenced Outputs Eliminate DC-Bias Voltage on Headphone Ground Pin**
- **No Degradation of Low-Frequency Response Due to Output Capacitors**
- **80mW into 32Ω Load from 5V Power Supply at THD+N = 0.1% (TYP, per Channel)**
- **Low 0.03% THD+N**
- **High PSRR (-78dB at 217Hz)**
- **Integrated Click-and-Pop Suppression**
- **2.7V to 5.1V Single Supply Operation**
- **Low Quiescent Current (5.8mA at $V_{DD} = 5V$)**
- **Shutdown Control**
- **Short-Circuit and Thermal-Overload Protections**
- **Under-Voltage Lockout Function**
- **-40°C to +85°C Operating Temperature Range**
- **Available in a Green TDFN-3×3-10L Package**

APPLICATIONS

Notebook PCs
Cellular Phones
PDAs
MP3 Players
Smart Phones
Portable Audio Equipment

PACKAGE/ORDERING INFORMATION

MODEL	GAIN (V/V)	PACKAGE DESCRIPTION	SPECIFIED TEMPERATURE RANGE	ORDERING NUMBER	PACKAGE MARKING	PACKING OPTION
SGM4918A	ADJ	TDFN-3×3-10L	-40°C to +85°C	SGM4918AYD10G/TR	SGM 4918AD XXXXX	Tape and Reel, 3000
SGM4918B	-2	TDFN-3×3-10L	-40°C to +85°C	SGM4918BYD10G/TR	SGM 4918BD XXXXX	Tape and Reel, 3000

MARKING INFORMATION

NOTE: XXXXX = Date Code and Vendor Code.

XXXXX

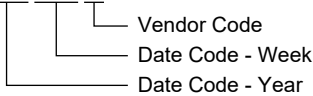

Green (RoHS & HSF): SG Micro Corp defines "Green" to mean Pb-Free (RoHS compatible) and free of halogen substances. If you have additional comments or questions, please contact your SGMICRO representative directly.

ABSOLUTE MAXIMUM RATINGS

- V_{DD} to GND -0.3V to +6V
- C1P to GND -0.3V to (V_{DD} + 0.3V)
- C1N to GND (V_{SS} - 0.3V) to + 0.3V
- V_{SS} to GND -6V to +0.3V
- OUTR, OUTL to GND (V_{SS} - 0.3V) to (V_{DD} + 0.3V)
- SHDN to GND -0.3V to +6V
- INR, INL to GND (V_{SS} - 0.3V) to (V_{DD} + 0.3V)
- Output Short Circuit to GND or VDD Continuous
- Junction Temperature +150°C
- Storage Temperature Range -65°C to +150°C
- Lead Temperature (Soldering, 10s) +260°C
- ESD Susceptibility
- HBM 3000V
- HBM (Output pins to Supply and Ground pins) 4000V
- MM 200V

RECOMMENDED OPERATING CONDITIONS

- Supply Voltage Range 2.7V to 5.1V
- Operating Temperature Range -40°C to +85°C

OVERSTRESS CAUTION

Stresses beyond those listed in Absolute Maximum Ratings may cause permanent damage to the device. Exposure to absolute maximum rating conditions for extended periods may affect reliability. Functional operation of the device at any conditions beyond those indicated in the Recommended Operating Conditions section is not implied.

ESD SENSITIVITY CAUTION

This integrated circuit can be damaged by ESD if you don't pay attention to ESD protection. SGMICRO recommends that all integrated circuits be handled with appropriate precautions. Failure to observe proper handling and installation procedures can cause damage. ESD damage can range from subtle performance degradation to complete device failure. Precision integrated circuits may be more susceptible to damage because very small parametric changes could cause the device not to meet its published specifications.

DISCLAIMER

SG Micro Corp reserves the right to make any change in circuit design, or specifications without prior notice.

PIN CONFIGURATION

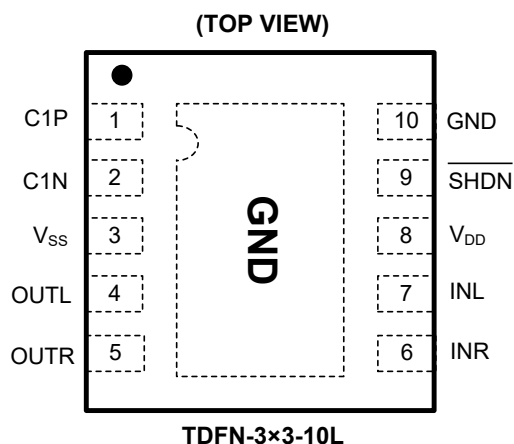

PIN DESCRIPTIONS

PIN	NAME	DESCRIPTION
1	C1P	Flying Capacitor Positive Terminal. Connect a 1 μ F ceramic capacitor from C1P to C1N.
2	C1N	Flying Capacitor Negative Terminal. Connect a 1 μ F ceramic capacitor from C1N to C1P.
3	VSS	Charge-Pump Output. Bypass with a 1 μ F capacitor to GND.
4	OUTL	Left-Channel Output.
5	OUTR	Right-Channel Output.
6	INR	Right-Channel Input.
7	INL	Left-Channel Input.
8	VDD	Positive Power-Supply Input. Bypass with 4.7 μ F and 0.1 μ F capacitor to GND.
9	$\overline{\text{SHDN}}$	Active-Low Shutdown Input.
10	GND	Signal Ground.
Exposed Paddle	GND	Exposed pad must be soldered to GND.

ELECTRICAL CHARACTERISTICS

(T_A = +25°C, V_{DD} = $\overline{\text{SHDN}}$ = 5V, V_{GND} = 0V, R_{IN} = R_F = 40kΩ (gain = -1V/V), C₁ = C₂ = 1μF, C₃ = 4.7μF, C₄ = 0.1μF, R_L = ∞, unless otherwise noted.)⁽¹⁾

PARAMETER	SYMBOL	CONDITIONS		MIN	TYP	MAX	UNITS
General							
Supply Voltage Range	V _{DD}			2.7		5.1	V
Under-Voltage Lockout	UVLO				2.2		V
Quiescent Supply Current	I _{DD}	$\overline{\text{SHDN}}$ = V _{DD}	V _{DD} = 3.3V		5.5		mA
			V _{DD} = 5V		5.8	8.2	
Shutdown Supply Current	I _{SHDN}	$\overline{\text{SHDN}}$ = 0V			0.01	3	μA
$\overline{\text{SHDN}}$ Input Logic High	V _{IH}			1.2			V
$\overline{\text{SHDN}}$ Input Logic Low	V _{IL}					0.4	V
Turn-On Time	t _{ON}	V _{DD} = 5V			2.8		ms
Amplifiers							
Output Offset Voltage	V _{OS}	Input AC-coupled to ground	V _{DD} = 3.3V		1.0		mV
			V _{DD} = 5V	-5.5	1.2	5.5	
Power Supply Rejection Ratio	PSRR	V _{DD} = 5V	f = 217Hz, V _{RIPPLE} = 200mV _{P-P}		-78		dB
			f = 1kHz, V _{RIPPLE} = 200mV _{P-P}		-68		
			f = 20kHz, V _{RIPPLE} = 200mV _{P-P}		-63		
Output Power	P _{OUT}	R _L = 32Ω + 1μH, f = 1kHz, THD+N = 0.1%	V _{DD} = 3.6V		40		mW
			V _{DD} = 5V		80		
Output Impedance in Shutdown		$\overline{\text{SHDN}}$ = 0V			2		kΩ
Total Harmonic Distortion Plus Noise	THD+N	V _{DD} = 3.6V	R _L = 32Ω + 1μH, f = 1kHz P _{OUT} = 10mW		0.02		%
		V _{DD} = 5V	R _L = 32Ω + 1μH, f = 1kHz P _{OUT} = 20mW		0.03		
Signal-to-Noise Ratio	SNR	V _{DD} = 5V, R _L = 32Ω + 1μH, P _{OUT} = 25mW, BW < 22kHz			100		dB
Crosstalk		L to R, R to L, f = 10kHz	R _L = 32Ω + 1μH, V _{OUT} = 360mV _{RMS}		68		dB
			R _L = 32Ω + 1μH, V _{OUT} = 2V _{RMS}		68		
Capacitive Drive	C _L	No sustained oscillations			200		pF
Charge-Pump Oscillator Frequency	f _{OSC}			200	345	515	kHz
Thermal Shutdown Threshold					140		°C
Thermal Shutdown Hysteresis					15		°C

NOTE:

1. For R_{IN}, R_F, C₁ and etc, please refer to the FUNCTIONAL DIAGRAM/TYPICAL APPLICATION CIRCUIT on page 8.

TYPICAL PERFORMANCE CHARACTERISTICS

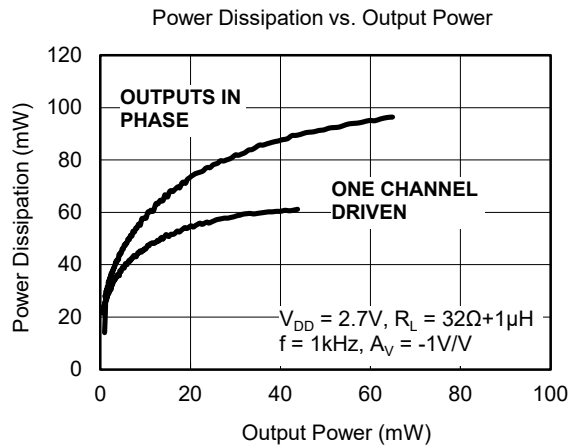
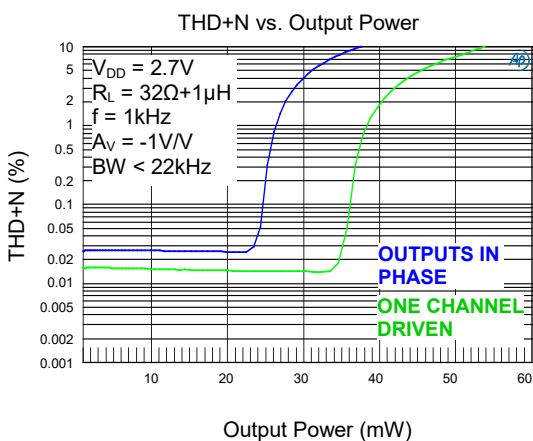
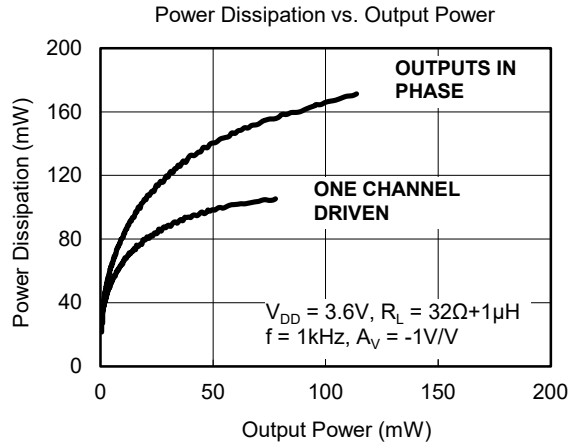
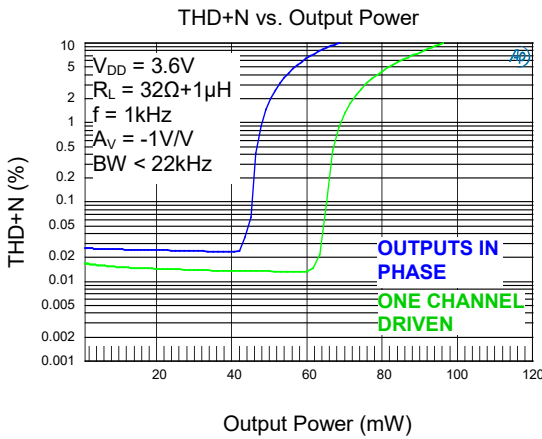
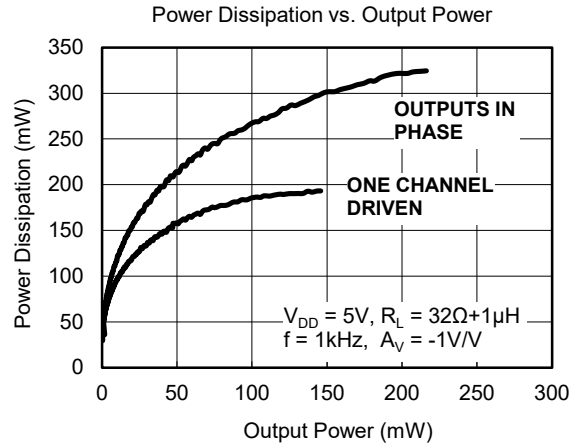
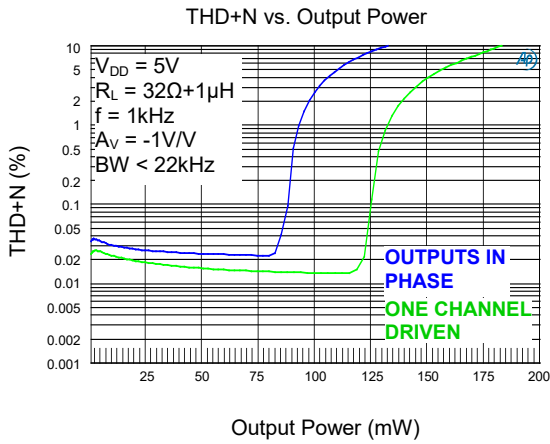

TYPICAL PERFORMANCE CHARACTERISTICS (continued)

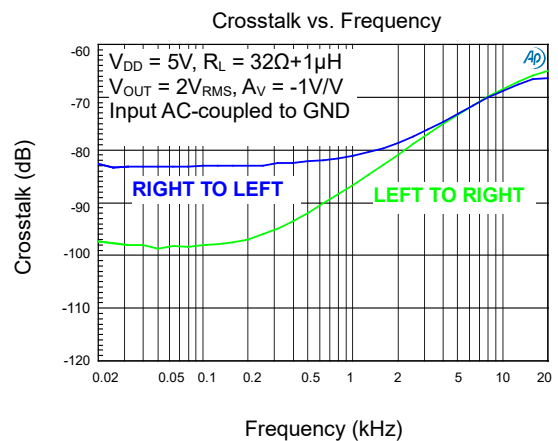
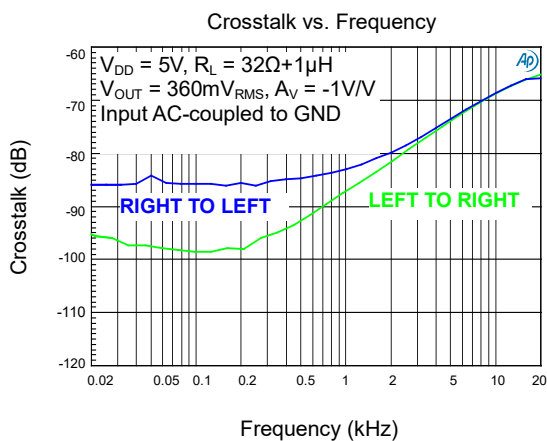
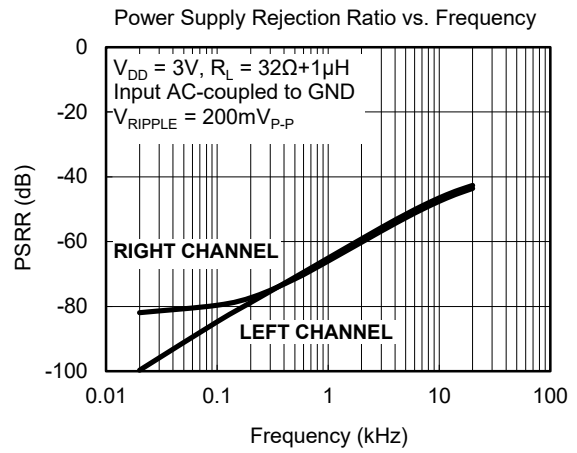
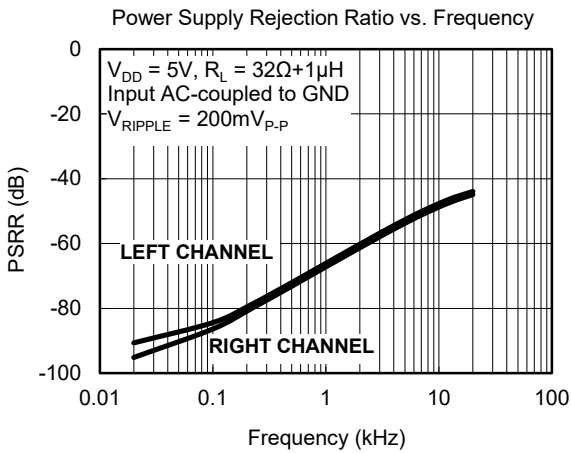
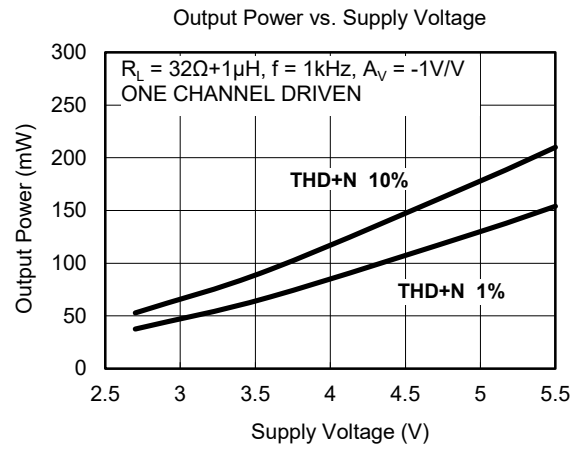
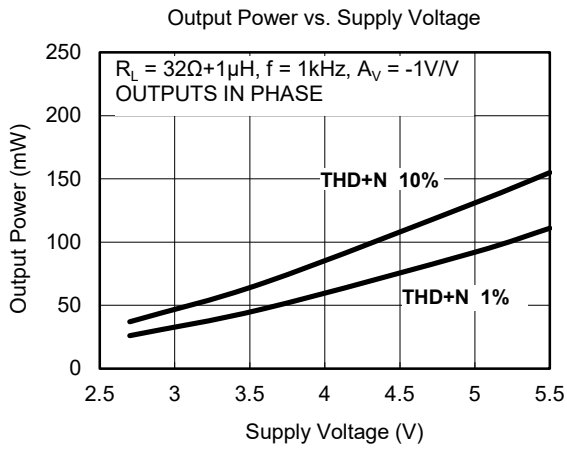

TYPICAL PERFORMANCE CHARACTERISTICS (continued)

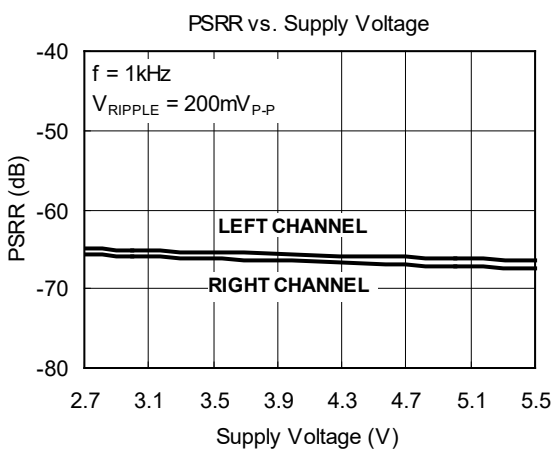
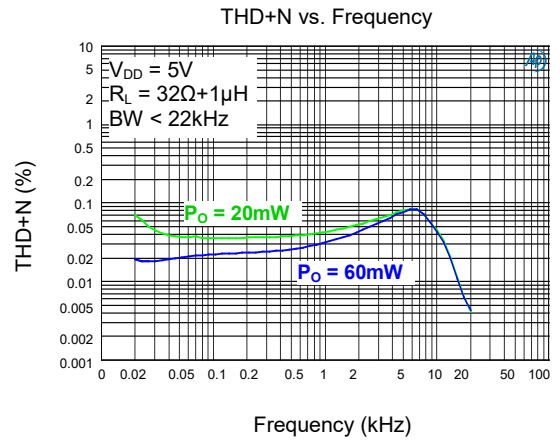
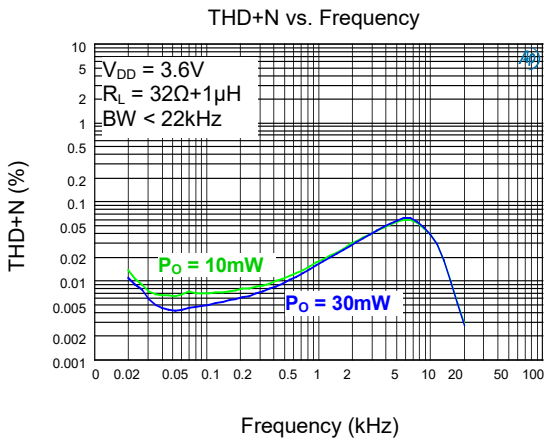
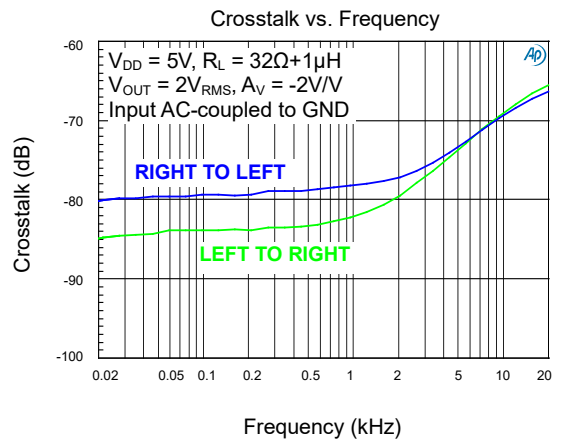
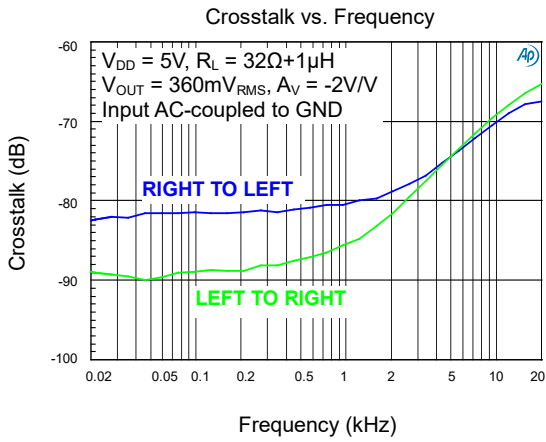

FUNCTIONAL DIAGRAM/TYPICAL APPLICATION CIRCUIT

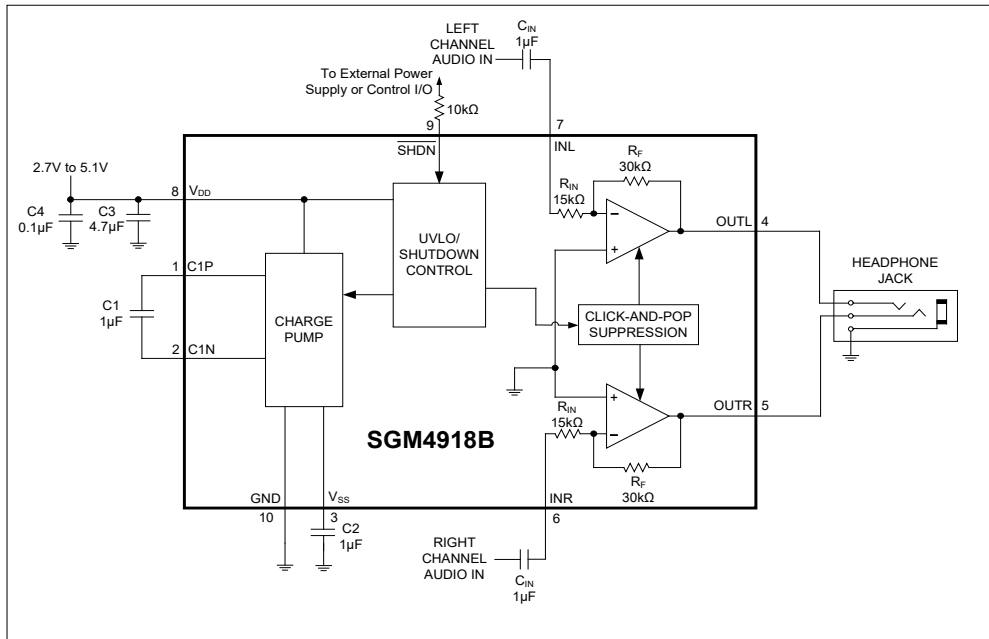
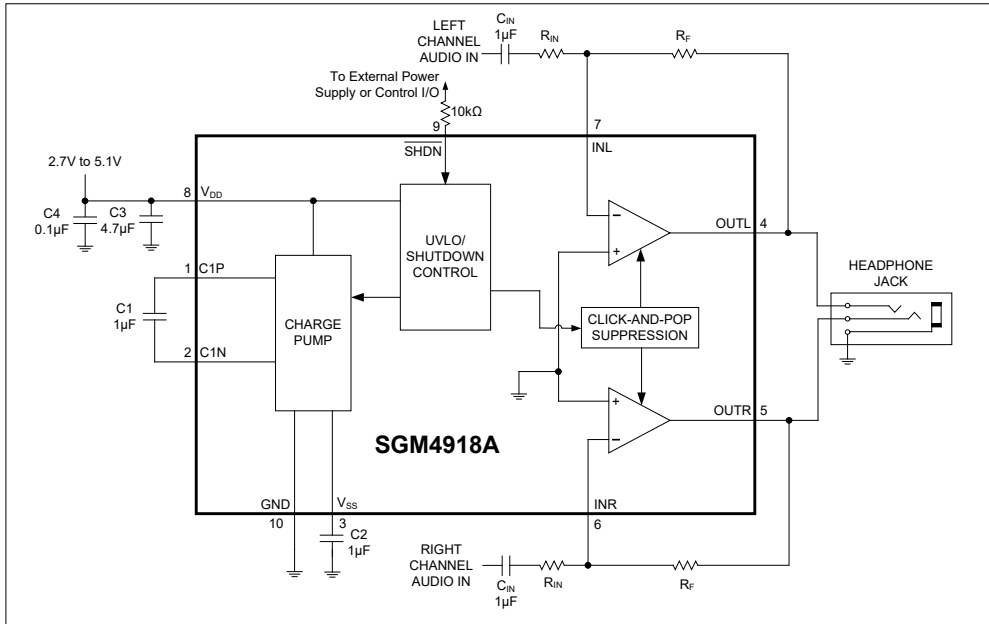

NOTES:

1. In order to get good performance, it's important to select the right C1, C2 and C3 in application. All tests are performed with circuit set up with X5R and X7R capacitors. Capacitors having high dissipative loss, such as Y5V capacitor, may cause performance degradation and unexpected system behavior.
2. A 10kΩ resistor must be serially connected to $\overline{\text{SHDN}}$ pin.

PCB LAYOUT GUIDE

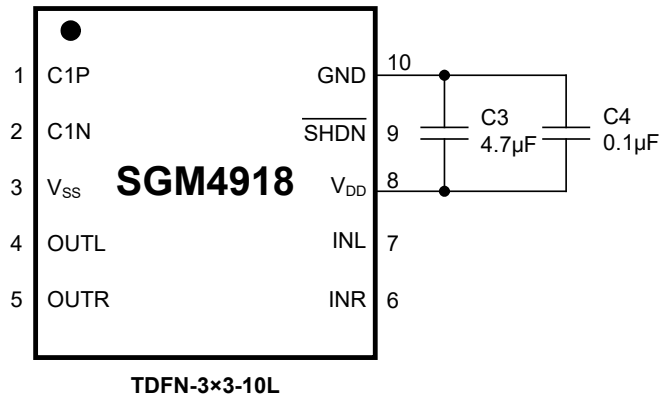

The reference PCB layout is shown below:

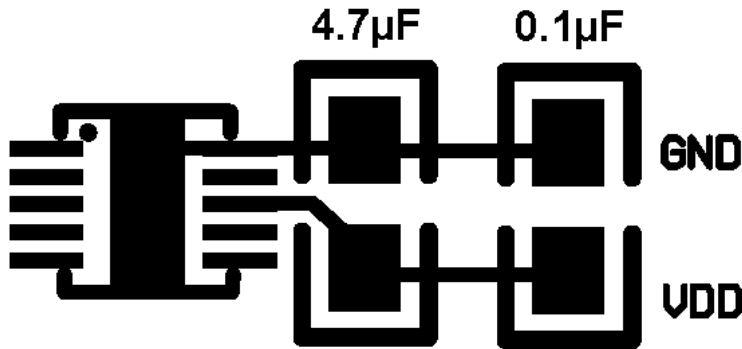

NOTES:

1. To ensure the normal operation of the device, decoupling capacitors (C3 and C4) must be placed as close to SGM4918 as possible. The loop length formed by C3/C4, V_{DD} and GND should be no longer than 5mm; otherwise the device will not start up at high supply voltage.
2. Proper layout and ground connection are essential for optimum performance. Connect Exposed Paddle and GND together at a single point on the PCB. Ensure ground return resistance is minimized for optimum THD and crosstalk performance. Place the power-supply bypass capacitor, the charge-pump hold capacitor, and the charge-pump flying capacitor as close as possible to the SGM4918. Route all traces that carry switching transients away from the audio signal path.

REVISION HISTORY

NOTE: Page numbers for previous revisions may differ from page numbers in the current version.

MARCH 2014 – REV.A.3 to REV.A.4

Changed V_{CC} All

AUGUST 2013 – REV.A.2 to REV.A.3

Updated ELECTRICAL CHARACTERISTICS and TYPICAL PERFORMANCE CHARACTERISTICS 4, 6, 7

NOVEMBER 2012 – REV.A.1 to REV.A.2

Added note for Typical Application Circuit 8

SEPTEMBER 2012 – REV.A to REV.A.1

Added Tape and Reel Information 11, 12

Changes from Original (FEBRUARY 2012) to REV.A

Changed from product preview to production data All

PACKAGE OUTLINE DIMENSIONS

TDFN-3x3-10L

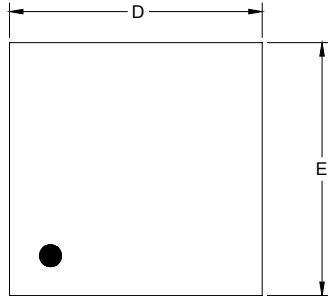

TOP VIEW

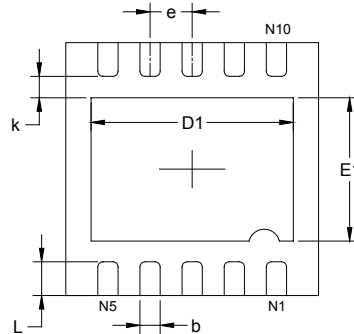

BOTTOM VIEW

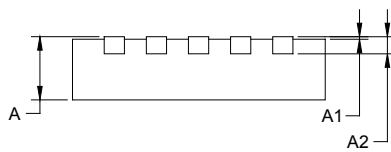

SIDE VIEW

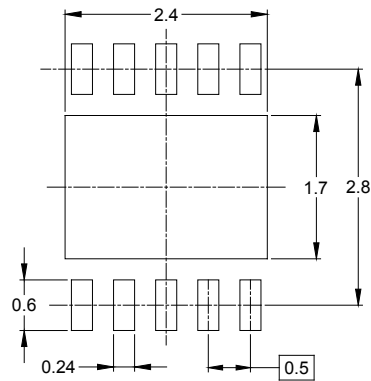

RECOMMENDED LAND PATTERN (Unit: mm)

Symbol	Dimensions In Millimeters		Dimensions In Inches	
	MIN	MAX	MIN	MAX
A	0.700	0.800	0.028	0.031
A1	0.000	0.050	0.000	0.002
A2	0.203 REF		0.008 REF	
D	2.900	3.100	0.114	0.122
D1	2.300	2.600	0.091	0.103
E	2.900	3.100	0.114	0.122
E1	1.500	1.800	0.059	0.071
k	0.200 MIN		0.008 MIN	
b	0.180	0.300	0.007	0.012
e	0.500 TYP		0.020 TYP	
L	0.300	0.500	0.012	0.020

PACKAGE INFORMATION

TAPE AND REEL INFORMATION

REEL DIMENSIONS



TAPE DIMENSIONS



NOTE: The picture is only for reference. Please make the object as the standard.

KEY PARAMETER LIST OF TAPE AND REEL

Package Type	Reel Diameter	Reel Width W1 (mm)	A0 (mm)	B0 (mm)	K0 (mm)	P0 (mm)	P1 (mm)	P2 (mm)	W (mm)	Pin1 Quadrant
TDFN-3×3-10L	13"	12.4	3.35	3.35	1.13	4.0	8.0	2.0	12.0	Q1

000001

PACKAGE INFORMATION

CARTON BOX DIMENSIONS



NOTE: The picture is only for reference. Please make the object as the standard.

KEY PARAMETER LIST OF CARTON BOX

Reel Type	Length (mm)	Width (mm)	Height (mm)	Pizza/Carton
13"	386	280	370	5

DD0002