



SGM4810

Dual 158mW Headphone Amplifier with Active High Shutdown Mode

GENERAL DESCRIPTION

The SGM4810 is a dual audio power amplifier capable of delivering 158mW per channel of continuous average power with typically 0.1% distortion (THD+N) when it drives a 16Ω speaker from a 5.0V power supply. It is designed to maximize audio performance in portable applications such as mobile phone. The portable application requires audio power amplifier has minimum of external components and can operate from a single 2.5V to 5.5V power supply.

SGM4810 features an externally controlled, active-high, micro-power consumption shutdown mode, as well as an internal thermal shutdown protection mechanism.

The SGM4810 does not require bootstrap capacitors or snubber networks. It is optimally suited for low power portable systems.

For maximum flexibility, the SGM4810 provides an externally controlled gain (with resistors), as well as an externally controlled turn-on time (with the bypass capacitor).

The SGM4810 is available in a Green MSOP-8 package. It operates over an ambient temperature range of -40°C to +85°C.

FEATURES

- **Active-High Shutdown Mode**
- **158mW into 16Ω Load from 5V Power Supply at THD+N = 0.1% (Typical, per Channel)**
- **87mW into 32Ω Load from 5V Power Supply at THD+N = 0.1% (Typical, per Channel)**
- **Unity Gain Stable**
- **2.5V to 5.5V Operation**
- **Shutdown Pin is Compatible with 1.8V Logic**
- **Shutdown Current: 0.5μA (TYP)**
- **Pop/Click Reduction Circuitry**
- **-40°C to +85°C Operating Temperature Range**
- **Available in Green a MSOP-8 Package**

APPLICATIONS

Portable Systems
Headphone Amplifier
Microphone Preamplifier
Notebook Computers
Mobile Phone
PDAs
GPS

PACKAGE/ORDERING INFORMATION

MODEL	PACKAGE DESCRIPTION	SPECIFIED TEMPERATURE RANGE	ORDERING NUMBER	PACKAGE MARKING	PACKING OPTION
SGM4810	MSOP-8	-40°C to +85°C	SGM4810YMS/TR	SGM4810 YMS XXXXX	Tape and Reel, 3000

MARKING INFORMATION

NOTE: XXXXX = Date Code and Vendor Code.

XXXXX

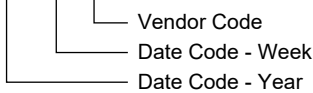

Green (RoHS & HSF): SG Micro Corp defines "Green" to mean Pb-Free (RoHS compatible) and free of halogen substances. If you have additional comments or questions, please contact your SGMICRO representative directly.

ABSOLUTE MAXIMUM RATINGS

- Supply Voltage.....6V
- Input Voltage.....-0.3V to (V+) + 0.3V
- Storage Temperature Range-65°C to +150°C
- Junction Temperature.....+150°C
- Lead Temperature Range (Soldering, 10s).....+260°C
- ESD Susceptibility
- HBM.....4000V
- MM.....400V

RECOMMENDED OPERATING CONDITIONS

- Supply Voltage Range2.5V to 5.5V
- Operating Temperature Range-40°C to +85°C

PIN CONFIGURATION

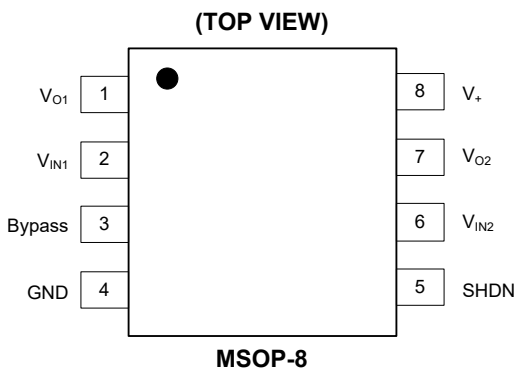

OVERSTRESS CAUTION

Stresses beyond those listed in Absolute Maximum Ratings may cause permanent damage to the device. Exposure to absolute maximum rating conditions for extended periods may affect reliability. Functional operation of the device at any conditions beyond those indicated in the Recommended Operating Conditions section is not implied.

ESD SENSITIVITY CAUTION

This integrated circuit can be damaged by ESD if you don't pay attention to ESD protection. SGMICRO recommends that all integrated circuits be handled with appropriate precautions. Failure to observe proper handling and installation procedures can cause damage. ESD damage can range from subtle performance degradation to complete device failure. Precision integrated circuits may be more susceptible to damage because very small parametric changes could cause the device not to meet its published specifications.

DISCLAIMER

SG Micro Corp reserves the right to make any change in circuit design, or specifications without prior notice.

ELECTRICAL CHARACTERISTICS

(T_A = +25°C, unless otherwise specified.)

PARAMETER	SYMBOL	CONDITIONS		MIN	TYP	MAX	UNITS
Supply Voltage	V ₊			2.5		5.5	V
Shutdown Current	I _{SD}	V _{IN} = 0V, V _{SHDN} = V ₊ = 5.0V			0.5	4	μA
		V _{IN} = 0V, V _{SHDN} = V ₊ = 3.3V			0.5		
		V _{IN} = 0V, V _{SHDN} = V ₊ = 2.6V			0.1		
Output Offset Voltage	V _{OS}	V _{IN} = 0V, V _{SHDN} = GND		-50	1	50	mV
Quiescent Power Supply Current	I _Q	V _{IN} = 0V, V _{SHDN} = GND	V ₊ = 5.0V, No Load		1.75	2.8	mA
			V ₊ = 3.3V, No Load		1.64		
			V ₊ = 2.6V, No Load		1.58		
Shutdown Voltage Input High	V _{SDIH}			1.8			V
Shutdown Voltage Input Low	V _{SDIL}					0.4	V
Output Power (per Channel)	P _O	f = 1kHz, THD+N = 0.1%	V ₊ = 5.0V	R _L = 16Ω		158	mW
				R _L = 32Ω		87	
			V ₊ = 3.6V	R _L = 16Ω		84	
				R _L = 32Ω		47	
			V ₊ = 3.0V	R _L = 16Ω		58	
				R _L = 32Ω		33	
			V ₊ = 2.6V	R _L = 16Ω		42	
				R _L = 32Ω		25	
Total Harmonic Distortion + Noise	THD+N	P _O = 78mWrms, V ₊ = 5.0V, R _L = 32Ω, f = 20Hz to 20kHz			0.3		%
Crosstalk	X _{TALK}	R _L = 32Ω, P _O = 70mW, V ₊ = 5V, f = 1kHz			-100		dB
Power Supply Rejection Ratio	PSRR	f = 217Hz	V ₊ = 5.0V			-62	dB
			V ₊ = 3.6V			-62	
			V ₊ = 3.0V			-62	
			V ₊ = 2.6V			-62	
		f = 1kHz	V ₊ = 5.0V			-71	
			V ₊ = 3.6V			-71	
			V ₊ = 3.0V			-71	
			V ₊ = 2.6V			-71	
Wake-Up Time	T _{WU}	V ₊ = 5.0V, C _{BYPASS} = 0.47μF, R _L = 16Ω			0.53		s

TYPICAL PERFORMANCE CHARACTERISTICS

Large Signal Step Response

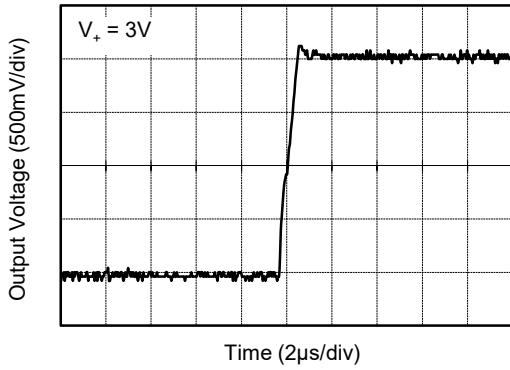

Small Signal Step Response

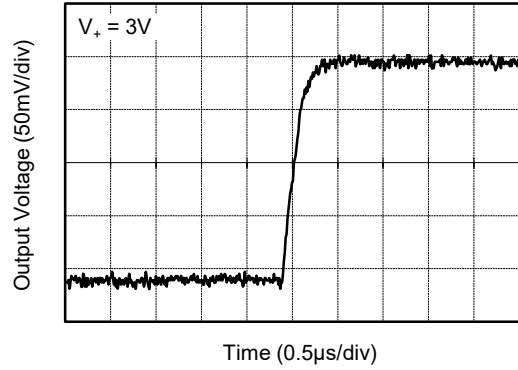

Large Signal Step Response

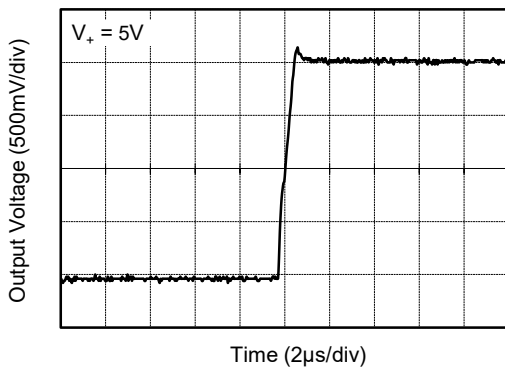

Small Signal Step Response

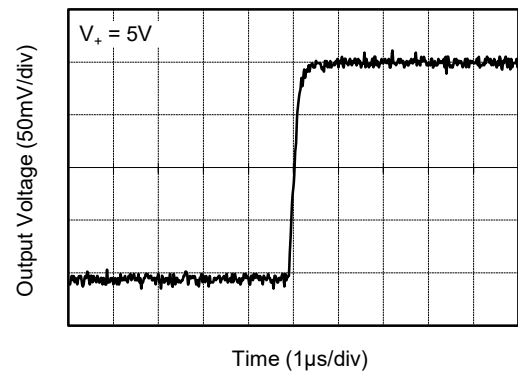

Small Signal Frequency Response

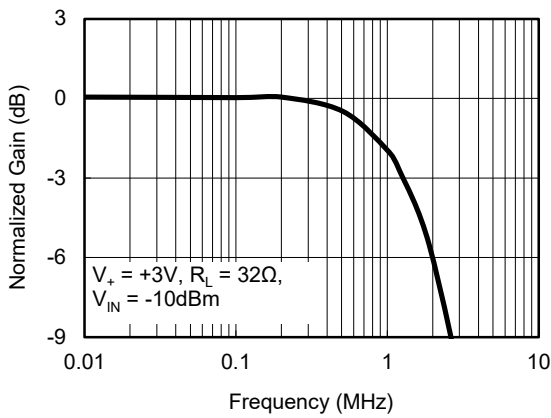

Small Signal Frequency Response

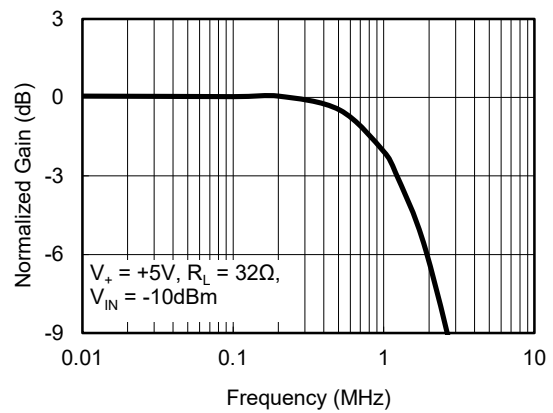

TYPICAL PERFORMANCE CHARACTERISTICS (continued)

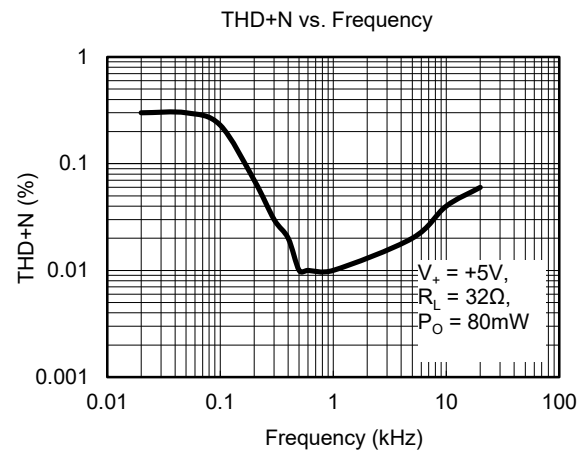
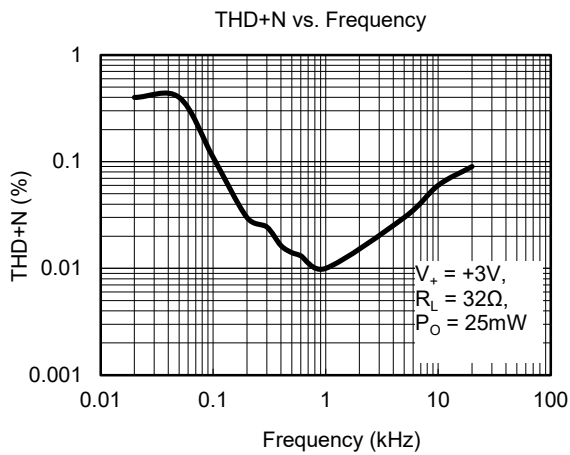
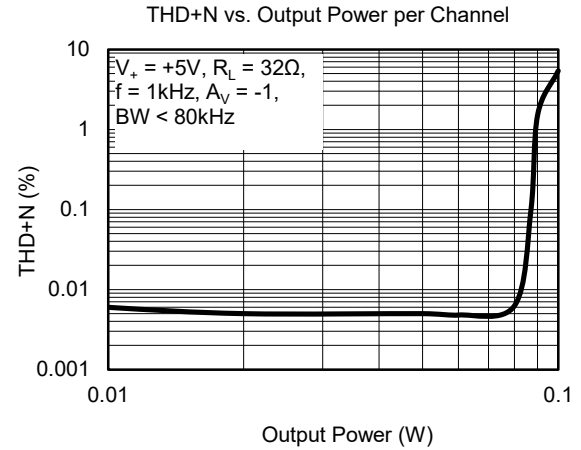
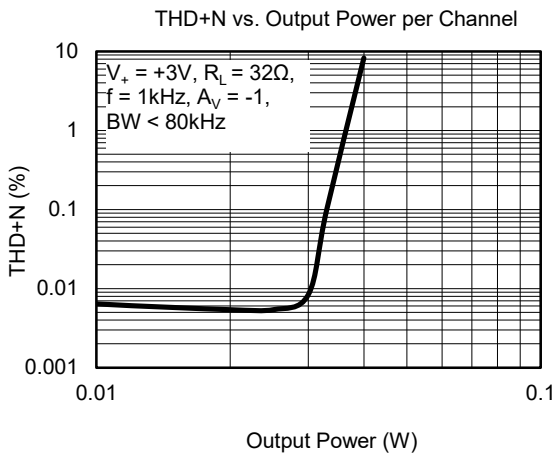
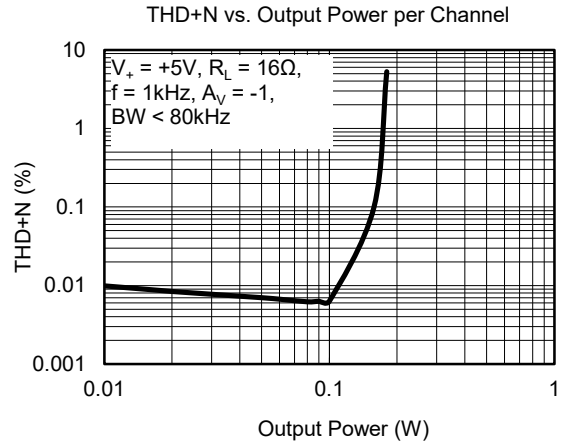
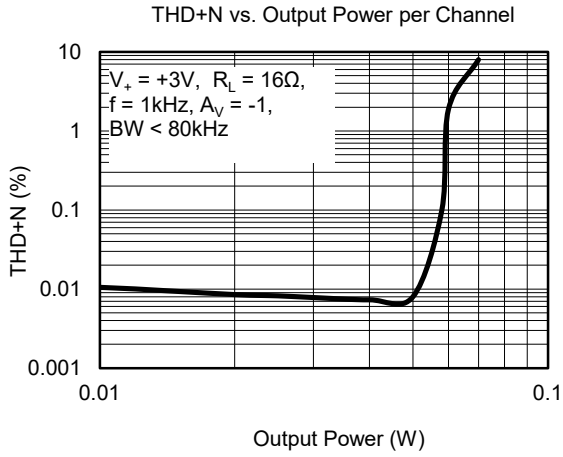

TYPICAL PERFORMANCE CHARACTERISTICS (continued)

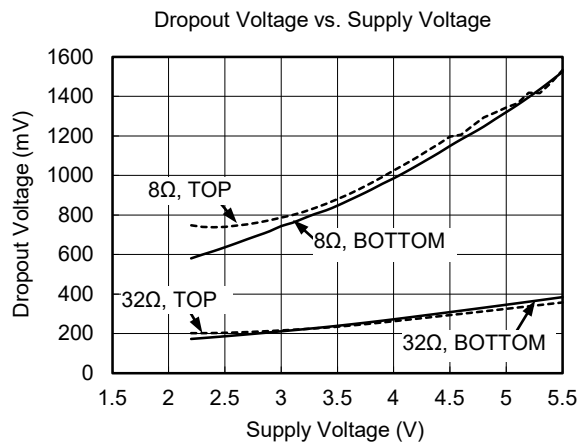
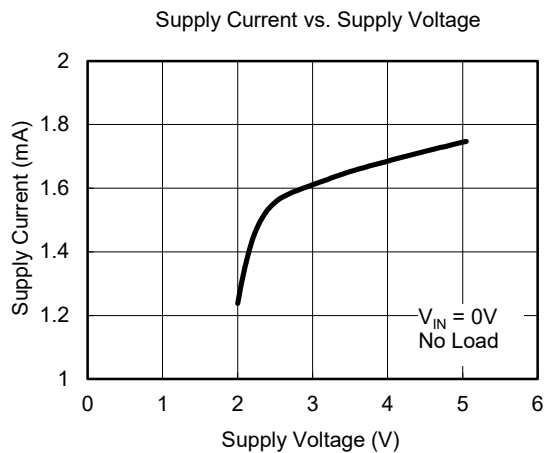

TYPICAL APPLICATION CIRCUIT

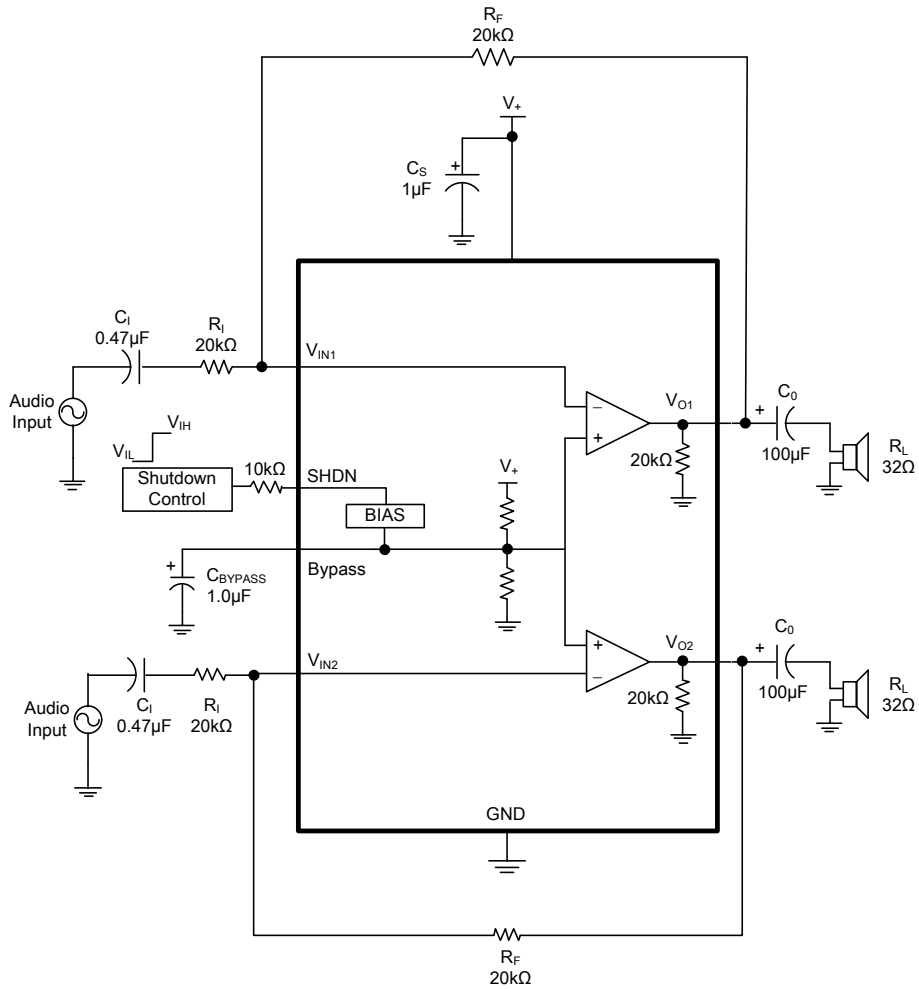

NOTE:
 1. A 10kΩ resistor must be serially connected to SHDN pin.

REVISION HISTORY

NOTE: Page numbers for previous revisions may differ from page numbers in the current version.

NOVEMBER 2012 – REV.A.1 to REV.A.2

Added note for Typical Application Circuit 7

MAY 2012 – REV.A to REV.A.1

Added Recommended Land Pattern Information 8

Added Tape and Reel Information 9-10

Changes from Original (JANUARY 2009) to REV.A

Changed from product preview to production data All

PACKAGE OUTLINE DIMENSIONS

MSOP-8



RECOMMENDED LAND PATTERN (Unit: mm)

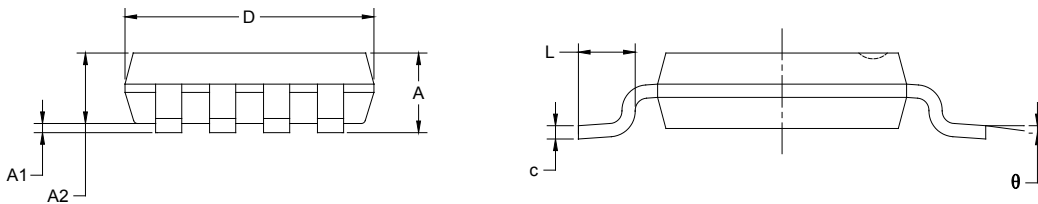

Symbol	Dimensions In Millimeters		Dimensions In Inches	
	MIN	MAX	MIN	MAX
A	0.820	1.100	0.032	0.043
A1	0.020	0.150	0.001	0.006
A2	0.750	0.950	0.030	0.037
b	0.250	0.380	0.010	0.015
c	0.090	0.230	0.004	0.009
D	2.900	3.100	0.114	0.122
E	2.900	3.100	0.114	0.122
E1	4.750	5.050	0.187	0.199
e	0.650 BSC		0.026 BSC	
L	0.400	0.800	0.016	0.031
θ	0°	6°	0°	6°

PACKAGE INFORMATION

TAPE AND REEL INFORMATION

REEL DIMENSIONS



TAPE DIMENSIONS

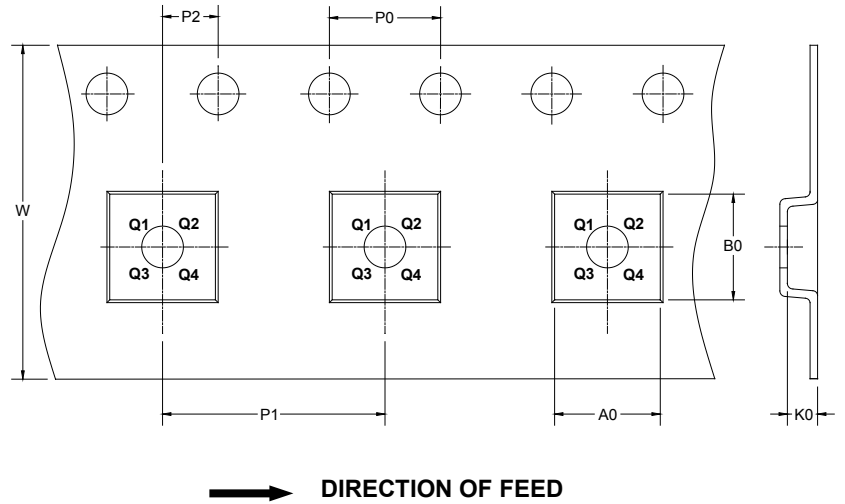

NOTE: The picture is only for reference. Please make the object as the standard.

KEY PARAMETER LIST OF TAPE AND REEL

Package Type	Reel Diameter	Reel Width W1 (mm)	A0 (mm)	B0 (mm)	K0 (mm)	P0 (mm)	P1 (mm)	P2 (mm)	W (mm)	Pin1 Quadrant
MSOP-8	13"	12.4	5.20	3.30	1.50	4.0	8.0	2.0	12.0	Q1

DD0001

PACKAGE INFORMATION

CARTON BOX DIMENSIONS



NOTE: The picture is only for reference. Please make the object as the standard.

KEY PARAMETER LIST OF CARTON BOX

Reel Type	Length (mm)	Width (mm)	Height (mm)	Pizza/Carton
13"	386	280	370	5

DD0002